

2203/1613

INSTRUCTIONS AND APPLICATIONS

**Precision Sound Level Meter
Type 2203
Octave Filter Set
Type 1613**

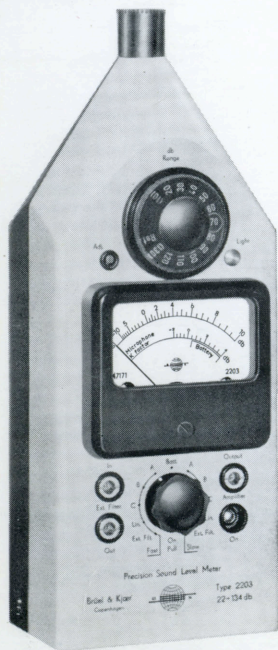

A portable sound level meter made for precision sound measurements but adaptable for measuring vibrations. When combined with the Octave Filter Set it becomes a compact analyser.

BRÜEL & KJÆR

Nærum, Denmark . ☎ 80 05 00 . ✉ BRUKJA, Copenhagen . Telex: 5316

BB 2203/1613

Accelerometers
Acoustic Standing Wave Apparatus
Artificial Ears
Artificial Voices
Audio Frequency Response Tracers
Audio Frequency Spectrometers
Audio Frequency Vacuum-Tube Voltmeters
Automatic A.F. Response and Spectrum Recorders
Automatic Vibration-Exciter Control Generators
Band-Pass Filter Sets
Beat Frequency Oscillators
Complex Modulus Apparatus
Condenser Microphones
Deviation Bridges
Distortion Measuring Bridges
Frequency Analyzers
Frequency Measuring Bridges
Hearing Aid Test Apparatus
Heterodyne Voltmeters
Level Recorders
Megohmmeters
Microphone Accessories
Microphone Amplifiers
Microphone Calibration Apparatus
Mobile Laboratories
Noise Generators
Noise Limit Indicators
Pistonphones
Polar Diagram Recorders
Preamplifiers
Precision Sound Level Meters
Recording Paper
Strain Gage Apparatus and Accessories
Surface Roughness Meters
Variable Frequency Rejection Filters
VHF-Converters
Vibration Pick-ups
Vibration Pick-up Preamplifiers
Wide Range Vacuum Tube Voltmeters



Precision Sound Level Meter

Type 2203/1613

Reprint May 1967

Contents

1. General	5
2. Sound Level Meter	11
Technical Description	12
Condenser Microphone and Cathode Follower	13
Input Amplifier	14
Weighting Network	14
Output Amplifiers and Attenuators	14
Rectifier and Indicating Meter	14
Power Supply	14
3. Filter Set Type 1613	15
Filter Characteristics	16
Weighting Potentiometers	17
4. Operation	19
Sound Level Meter	19
Octave Filter Set	21
Calibration Checks	21
Measurement of Sound	22
Measurement of Vibration	23
Operation	24
Specifications for Integrator ZR 0020	25
Use of External Filters	26
5. Accuracy of Measurements	27
Condenser Microphone	27
Amplifiers	28
Meter	28
Calibration Signal	29
Power Supply	29
Weighting Network	30
Effects of Vibration and Sound	33
Effects of Electric and Magnetic Fields	34
Distortion	36
Inherent Noise Levels	37
6. Operating Characteristics	38
Directional Characteristics	38
Notes on Reflection	40
Influence of Background Noise	43

7. Methods of Calibration	45
Noise Source Type 4240	45
Pistonphone Type 4220	46
8. Accessories	48
9. Applications	56
Noise	57
Vibration	57
Frequency Response of 4-pole Networks	58
Tape Recording of Sound and Vibration Data	58
Frequency Response and Directivity Pattern of Loudspeakers	60
Statistical Distribution of Sound Levels	60
Sound and Vibration Spectrograms	61
10. Appendix	63
11. Specifications	64

1. General

Vibration and Sound.

It is generally known that sound is a transmission of energy through solid, liquid or gaseous media in the form of vibrations. These vibrations constitute variations in pressure or position of the particles in the medium.

Sound may also be defined as the auditory sensation evoked when such vibrations, normally in air, impinge upon the ear. As an auditory sensation sound is limited to frequencies in the range from about 20 Hz to 20000 Hz. Pressure fluctuations outside this range will not generally produce the sensation of sound.

The Decibel Scale.

Acoustical instruments for measuring pressure variations are usually calibrated in dB (decibel). A dB value is a measure of relative power, i.e. so many dB above a reference power level:—

$$\text{dB} = 10 \log \frac{P}{P_0}$$

where P_0 is the reference and P is the actual power measured. However, the power transmitted by a sound wave is proportional to the square of the pressure variations so that we have

$$\text{dB} = 10 \log \frac{p^2}{p_0^2} = 20 \log \frac{p}{p_0}$$

where p_0 is the reference pressure and p is the root mean square value of the pressure variations. When sound pressure is measured in dB re 0.0002 μbar with equal weight given to all frequencies it is termed *sound pressure level*.

The logarithmic scale has been found very convenient because of the large range of sound intensities that the human ear can handle. It can detect pressure variations as low as 0.0002 μbar and can also withstand levels higher than 200 μbar . This is a ratio of more than $10^6:1$ which on the logarithmic scale is represented by 120 dB.

In Table 1.1 are given some commonly encountered sound pressure levels in order to give a better appreciation of the dB scale.

Sound pressure in bar	Sound level in dB	Environmental conditions
	140	
1 mbar	134 dB	Threshold of pain
	130	Pneumatic Chipper
100 μ bar	114 dB	Loud automobile horn (dist. 1 m)
	110	Inside airliner (DC 6)
10 μ bar	94 dB	Inside subway train (New York)
	90	Inside motor bus
1 μ bar	74 dB	Average traffic on street corner
	70	Conversational speech
0.1 μ bar	54 dB	Typical business office
	50	Living room, suburban area
0.01 μ bar	34 dB	Library
	30	Bedroom at night
0.001 μ bar	14 dB	Broadcasting studio
	10	
0.0002 μ bar	0	Threshold of hearing

Table 1.1. Some commonly encountered sound pressure levels.

The Detection of Sound.

The human ear is a remarkably sensitive instrument for the detection of sound waves. Its response to a certain sound pressure level depends however upon the frequency of the sound. The sensitivity is greatest at 1000—6000 Hz and falls off both for higher and lower frequencies.

A set of so-called equal loudness contours is given in Fig. 1.2. The curves show the intensity levels in dB re $0.0002 \mu\text{bar}$, which at various frequencies are judged by the average human to sound equally loud. Other sets of equal loudness contours which deviate from these curves in certain respects have been published by various investigators but the curves shown in Fig. 1.2 have been recommended as standard by the International Organization for Standardization (ISO/R 226-1961 (E)).

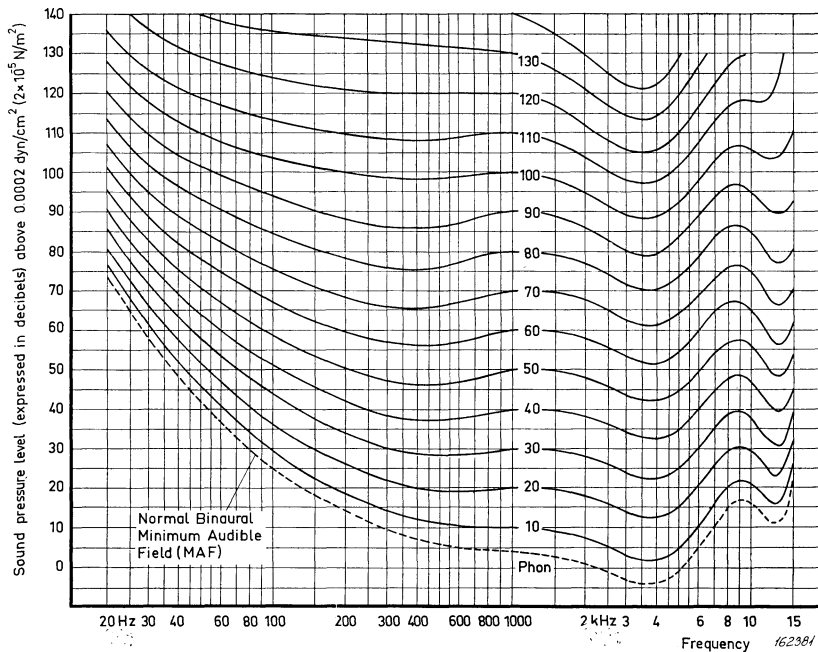

Fig. 1.2. Equal loudness contours.

The reference level is usually set up at 1000 Hz and the curves give the sound pressure level in dB necessary for a tone of a different frequency to sound equally loud. The loudness level is measured in phon and at 1000 Hz the phon value is equal to the dB value. It will be seen that the curves of constant phon become more and more straight as the loudness level is increased. At a level of 120 phon the ear is approximately equally sensitive to all frequencies in the audible range, while at 0 phon the variation in sound pressure level with frequency is great.

Although the response of the human ear depends on many other things beside frequency, modern sound level meters usually contain weighting networks in order to try and incorporate in the meter a frequency response similar to that of the human ear. Three different curves have been inter-

nationally agreed upon and standardized. These are referred to as the A, B and C curves and are shown in Fig. 1.3. When sound pressure is measured using one of the weighting networks and quoted in dB re 0.0002 μ bar it is termed *sound level*. The weighting network used should always be stated clearly e.g. if the sound level measured with the A weighting network is 70 dB, it should be quoted as 70 dB (A).

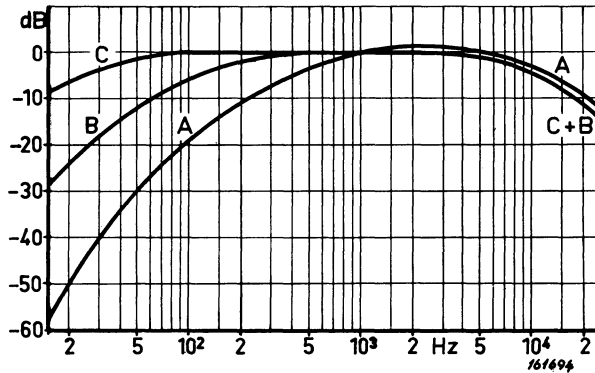

Fig. 1.3. Graph showing the response of the built-in weighting networks.

The Detection of Vibration.

A phenomenon which is closely related to what we usually think of as sound is vibrations in solid materials. Such vibrations are in most cases the source of sound and may have to be located in order to reduce their effect. (Noise control). Man's sensitivity to vibration is extremely limited, especially for the higher frequencies, so that measuring instruments are needed in order to determine accurately the vibrations in question. By substituting an accelerometer for the microphone, a sound level meter can usually be adapted to measure vibration instead of sound level and thus serve a dual purpose in the fight against excessive noise.

Noise and Vibration Analysis.

When measuring sound and vibration, more information can be gained if bandpass filters are used in connection with the sound level meter. It is then possible to determine a magnitude versus frequency relation for the sound or vibration in question. This is of great value in noise rating and especially in noise control, as the knowledge of the frequency of a sound often determines the method used for reducing it. Knowing the frequency of vibration on some industrial machinery can also be very helpful in localizing the source of this vibration.

Good sound level meters therefore have means for connecting external filters for frequency analysis of the incoming signal.

Loudness Evaluation and Noise Rating.

Due to man's technical "progress" our ears have to suffer increased sound levels almost wherever we go. This situation has developed to such an extent that something has to be done in order to keep control on sound levels, especially in towns and industrial areas where many people are subjected to a lot of noise.

Methods have therefore been sought whereby a sound level meter can be utilized for determining such factors as annoyance, hearing damage risk, possible interference with conversation etc. in connection with noises of widely different character. The first attempt was the introduction of the weighting curves A, B and C as described above. It was soon realized however, that sounds measured to be equally loud e.g. with the A weighting, did not necessarily cause the same annoyance or the same damage to hearing.

There are now in existence several methods for loudness determination, (see B & K Technical Review No 2-1962), but much research has still to be done with regard to the different aspects of human hearing before the methods can be considered absolutely reliable.

Certain aspects of a noise "rating" system with respect to the conservation of hearing, speech communication and annoyance are also being considered internationally. In this system a so-called Noise Rating Number, N, should be determined by using a sound level meter with octave filters. N is then related to the probable hearing loss or annoyance etc. that would result if a human being were exposed to the noise measured.

The noise rating number is defined as

$$N = \frac{L - a}{b}$$

where L is the octave band sound pressure level in dB re 0.0002 μ bar and a and b are constants given in Table 1.4.

Midfrequency of Octave Band, Hz	a dB	b dB
63	35.5	0.790
125	22.0	0.870
250	12.0	0.930
500	4.8	0.974
1000	0	1.000
2000	-3.5	1.015
4000	-6.1	1.025
8000	-8.0	1.030

Table 1.4. The constants a and b for the most important octave bands.

Conservation of Hearing.

Determine N for each of the three octave bands with centre frequencies 500, 1000 and 2000 Hz. The noise rating number is the highest of these numbers. N = 85 is proposed as a limit for conservation of hearing because habitual exposure to such a noise for 10 years may be expected to result in a negligible loss in hearing for speech of an average individual.

Speech Communication.

The above noise rating number may also be used in order to determine the probable interference with speech communication in noisy surroundings. Procedure: Determine the noise rating number N as for conservation of hearing above. Then use Table 1.5 to determine if the noise rating number is permissible for the case considered.

Noise Rating Number	Distance at which everyday speech of conversational voice level is considered to be intelligible		Distance at which everyday speech of raised voice level is considered to be intelligible	
	m	ft	m	ft
40	7	23	14	46
45	4	13	8	26
50	2.2	7.2	4.5	15
55	1.3	4.1	2.5	8.2
60	0.7	2.3	1.4	4.6
65	0.4	1.3	0.8	2.6
70	0.22	0.74	0.45	1.5
75	0.13	0.41	0.25	0.82
80	0.07	0.23	0.14	0.46
85	—	—	0.08	0.26

Table 1.5. Permissible noise rating numbers for speech communication.

2. B & K Sound Level Meter Type 2203

Sound Level Meters.

Sound level meters are required to measure noise of different levels, spectra and waveforms under widely varying conditions of sound source distribution and reflections at the sound field boundaries. Usually the purpose of these measurements, whether they are estimating hearing damage risk, annoyance, acoustical insulation efficiency, acceptability of manufactured products or any other factor, is to collect data which will improve our understanding of the problem and also help in solving it.

Obviously an instrument giving readings that can be related to subjective impressions of loudness would be desirable. Attempts have been made in the past to design such an instrument, but in view of the difficulties involved in simulating the human hearing system for all types of noise, the International Electrotechnical Commission (IEC), has decided that the most practical solution is simply to standardize an apparatus by which sound pressure can be measured under closely defined conditions, so that results obtained by different users can be compared.

The Type 2203 Sound Level Meter is an instrument with a practical combination of characteristics that will achieve a high degree of stability and accuracy. The accuracy and validity of the results are, however, determined by the manner of use, which must be chosen to suit the situation. In particular, care must be taken so that the presence of the observer does not invalidate the calibration. The instrument is not intended for measuring sounds of very short duration or discontinuous sounds.

Some of the main requirements in the IEC specification are quoted here:

A precision sound level meter shall include at least one of the three weighting networks called A, B or C, and should cover the frequency range 20 to 20000 Hz within certain tolerances. (Table 5.6).

The microphone shall be of the omnidirectional pressure type. Permissible tolerances on the variation of sensitivity with angle are given in Table 2.1, and it is suggested that the diffuse sound field sensitivity (i.e. the root-mean-square of the sensitivities for all orientations) should by some means be brought within the tolerances already mentioned for the specified incidence.

A square law indication instrument is specified, i.e. it must be capable of correctly summing two pure tones according to the root-mean-square law.

The Precision Sound Level Meter Type 2203 is a highly accurate instrument designed for outdoor use as well as for precise laboratory measurements. It

Frequency Range Hz	Tolerances ∠ 30° Incidence dB		Tolerances 90° Incidence dB	
31.5— 1000	+ 0.5	- 0.5	+ 1	- 1
1000— 2000	+ 0.5	- 0.5	+ 1	- 2
2000— 4000	+ 0.5	- 1.0	+ 1	- 3
4000— 8000	+ 0.5	- 1.5	+ 1	- 6
8000—12500	+ 0.5	- 2.0	+ 1	- 10

Table 2.1. Permissible variation of sensitivity with angle of incidence.

is easily portable, battery driven and completely self-contained for ordinary sound level and vibration measurements. Used in conjunction with a suitable filter set e.g. the B & K Octave Filter Set Type 1613, the instrument becomes a handy and easily operated frequency analyzer.

There are no requirements stated in the IEC Draft Specification regarding dynamic range, but the B & K Type 2203 covers the range 18 to 134 dB (or 39 to 148 dB using a 1/2" microphone) and as will be seen from Table 1.1 this covers most sound levels which need to be measured. All three weighting networks (A, B and C) are included in the instrument as well as a linear characteristic and means for connecting external filter circuits for further shaping of the frequency characteristic if necessary.

From instrument serial No. 82939 the Sound Level Meter complies with the American Standard for General Purpose Sound Level Meters, ASA S 1.4-1961.

Technical Description.

A block diagram of the instrument is given in Fig. 2.2.

The instrument can be divided into the following main parts:—

1. Condenser microphone and source follower.
2. Input amplifier with input attenuator.

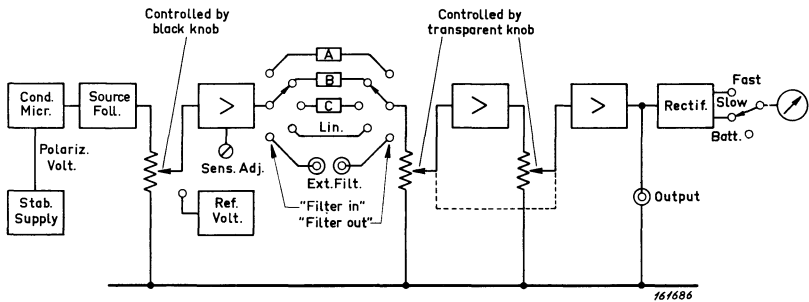

Fig. 2.2. Block diagram of Type 2203.

3. Weighting networks.
4. Output amplifiers with output attenuators.
5. Meter rectifier and indicating meter.
6. Power supply.

Condenser Microphone and Cathode Follower.

The microphone supplied with the Sound Level Meter is a precision measuring condenser microphone designed for long term stability and high accuracy. Particular care has been taken to make it insensitive to variations in ambient conditions such as temperature, pressure and relative humidity. The construction of the microphone can be inferred from the schematic diagram in Fig. 2.3. It consists essentially of a thin metallic diaphragm mounted in close proximity to a rigid back plate. Diaphragm and back plate are electrically insulated from each other and constitute the electrodes of a capacitor. The capacitor is charged by a DC polarization voltage and the charging time constant is made so high that for the frequency range of ordinary acoustical measurements the charge on the capacitor will be constant.

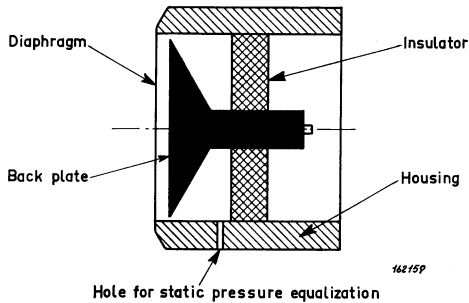

Fig. 2.3. Schematic construction of a condenser microphone cartridge.

When the distance between the diaphragm and the back plate changes because of variations in pressure on the diaphragm the capacity will also change and so an alternating voltage appears across the capacitor. This voltage component is proportional to the pressure fluctuations within the linear range of the microphone.

The low internal capacitance of the microphone requires a high input impedance in the succeeding amplifier stage in order to ensure a minimum loss in sensitivity due to loading. A source-follower stage has therefore been introduced between the microphone and the input amplifier. This source-follower stage consists of a low noise silicon field-effect transistor (FET) and two other silicon planar transistors. This stage has a very high input impedance of approximately 2 Gohm (2×10^9 ohm) and a low output impedance.

Input Amplifier and Attenuator.

The input attenuator follows immediately after the source follower stage and is designed for accurate attenuation of the input signal in steps of 10 dB. A great amount of negative feedback is introduced in the amplifier in order to ensure a high input impedance and stable operation. For calibration purposes the amplification of this stage can be altered a few dB by means of a potentiometer which changes the amount of negative feedback in the circuit.

Weighting Networks.

The weighting networks (A, B and C) are introduced between the input amplifier and the first output amplifier. They are built into the instrument and can be switched into circuit by means of a knob on the front plate. Terminals are also provided for the connection of external filters such as octave or 1/3 octave filters for sound analysis. The output impedance of the EXT. FILTER IN terminals is approximately 25 ohm, while the input impedance of the EXT. FILTER OUT terminals is 146 kohm in parallel with 45 pF.

Output Amplifiers and Attenuators.

The output from the filter circuits is fed through two amplifier stages with associated attenuators. The attenuation can be varied accurately in steps of 10 dB. Stable operation is ensured by means of a large amount of negative feedback.

Rectifier and Indicating Meter.

After frequency weighting and amplification the signal is fed to a rectifier and then to the indicating meter. The rectifier is a full wave rectifier with characteristics as required in the IEC standard for sound level meters (Publication 179), providing a rectified signal which corresponds to the RMS value of the input from the microphone. This rectified signal is fed to a moving coil indicating meter which includes two different degrees of damping, "Fast" and "Slow", both in accordance with the IEC standard for precision sound level meters. The meter itself is ribbon suspended in order to make it less sensitive to shock and vibration.

Power Supply.

The Sound Level Meter is powered by three ordinary 1.5 V torch batteries, and to avoid bad contact due to corrosion the battery clips are gold plated, ensuring a negligible contact resistance.

The HT is obtained from a highly stabilized transistor oscillator working at a frequency of 1 kHz. The same generator supplies a signal which is used as a calibration signal for the amplifiers and meter circuit, and also one that is rectified and used as polarization voltage (200 V) for the microphone.

3. The Filter Set Type 1613

The Octave Filter Set is a compact, portable unit containing 11 band-pass filters for octave analysis. It is primarily designed for use in conjunction with the Precision Sound Level Meter Type 2203, the combination being a portable noise and vibration analyzer. Only four screws are used for joining the units together and the electrical connection is provided by a connection bar as shown in Fig. 3.1.

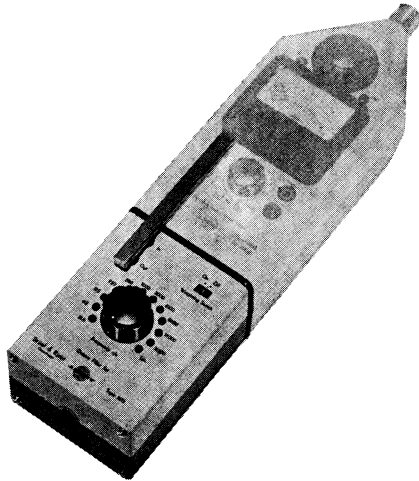

Fig. 3.1. The Octave Filter Set Type 1613 joined to the Sound Level Meter.

The Filter Set may also be used in connection with other instruments, such as the B & K microphone amplifiers:—

With Microphone Amplifier Type 2603.

For connection use two low capacity cables, AO 0034 to the filter input and AO 0035 from the filter output. The latter contains a built-in shunt resistor which loads the filters correctly.

With Microphone Amplifier Type 2604.

The amplifier itself loads the filters correctly and no additional shunt resistor is needed. Therefore the cable AO 0034 must be used from the filter output. The shunted cable, AO 0035 may be used for the filter input without affecting performance.

Filter Characteristics.

The cut-off frequencies f_1 and f_2 (3 dB attenuation) of the filters are equal distances away from the centre frequency f_0 on a logarithmic scale. Thus $f_1 = f_0 / \sqrt{2}$, $f_2 = f_0 \sqrt{2}$ and $f_2 = 2f_1$ i.e. an octave filter with centre frequency 1000 Hz has cut-off frequencies 707 and 1414 Hz. The shape of the attenuation curves is seen from Fig. 3.2. Inside the pass-band the response is flat to within ± 0.5 dB and outside the 3 dB attenuation points the slope of the characteristic is about 45–50 dB/Octave. One octave away from the cut-off frequency the attenuation is approximately 40 dB. A complete set of filter characteristics is shown in Fig. 3.3.

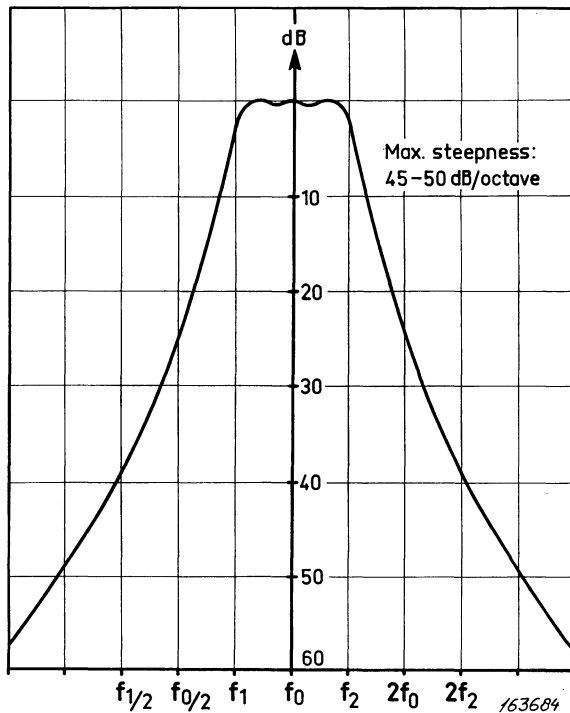

Fig. 3.2. Filter characteristic of one of the octave filters.

The Filter Set Type 1613 contains 11 filters with centre frequencies in accordance with ISO standards as follows: 31.5 — 63 — 125 — 250 — 500 — 1000 — 2000 — 4000 — 8000 — 16000 and 31500 Hz. The overall range of the Filter Set is thus 22 Hz to 45 kHz.

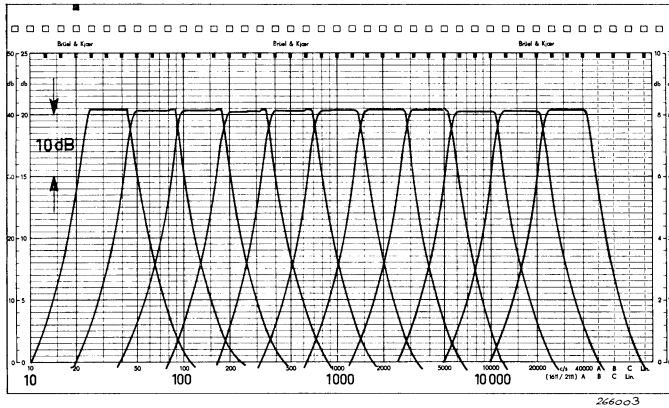

Fig. 3.3. Complete set of filter characteristics for Type 1613.

Weighting Potentiometers.

Each filter output is paralleled by a potentiometer which makes it possible to attenuate the signal from the pass-band by anything from 0 to 50 dB. This may be useful when it is desired to weight the filter characteristics to noise limit requirements for particular applications. An example of such weighting is given in Fig. 3.4.

The potentiometers are adjusted with the aid of a screwdriver through small holes in the front cover. A signal source of variable frequency is necessary for the adjustment. The signal may be electrical when the Adaptor JJ 2612 is used with the Sound Level Meter, or acoustical when the microphone is employed. The Sound Level Meter is used as an indicator and the potentiometers are switched in and out by means of a switch in the upper right hand corner of the front plate. When the Filter Set is used with the Sound Level Meter Type 2203 correct impedance matching is obtained.

Note: Using the Filter Set with other instruments it should be remembered that the impedance of the signal source should be less than 25 ohm and the load resistance should be 146 Kohm in parallel with 50 — 80 pF. The maximum input voltage that can be applied to the filters without noticeable distortion is approximately 1 V. Type 2203 supplies 0.3 V at full scale deflection of the meter.

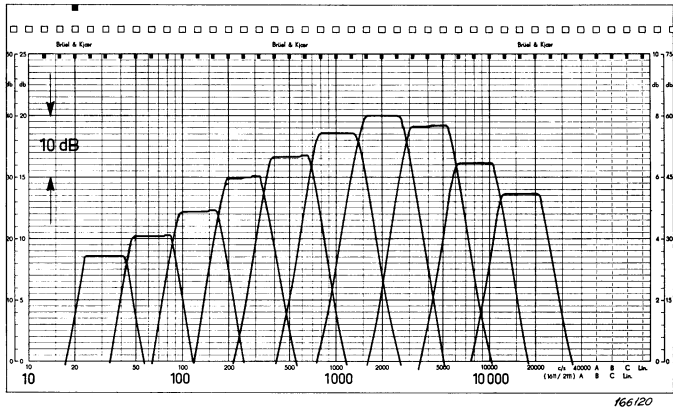

Fig. 3.4. *The attenuation in the pass band can be individually adjusted for each filter.*

4. Operation

Sound Level Meter.

The most important knobs on the Sound Level Meter are marked 1, 2 and 3 in Fig. 4.1.

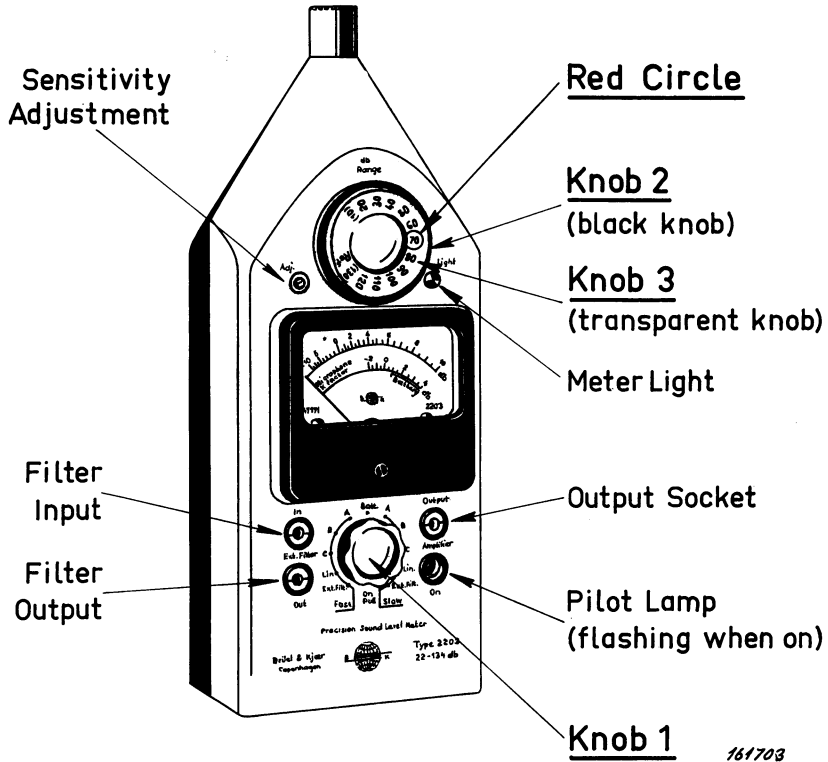

Fig. 4.1. The Sound Level Meter with identification of knobs.

KNOB 1.

This is a function selector as well as the power switch. When the knob is pulled out the power is on. This is indicated by a flashing pilot lamp, which should remind the operator to switch off when the instrument is not in use. When pulled out the knob is used as follows: —

Switching to the position marked "Batt." makes the meter pointer deflect. If this deflection is within the range marked "Battery" on the meter scale, the batteries are serviceable, otherwise replace. See "Calibration Check" page 20. The other positions of the knob marked A, B and C on either side are used for connection of the built-in weighting networks. "Lin." gives the meter a linear frequency response and "Ext. Filt." is used when an external filter or weighting network is connected to the meter. The right hand positions are used when a high damping of the meter is desired, while the left hand positions are used for normal damping.

KNOB 2 and KNOB 3.

These are range setting switches operating in conjunction with each other. (KNOB 2 controls the input attenuator and KNOB 3 the output attenuators). When there is a deflection on the meter the value indicated should be added to the figure in the circle to give the correct result of the measurement. KNOB 3 should always be as far clockwise as possible as this gives the best signal to noise ratio.

SENSITIVITY ADJUSTMENT

This is a screwdriver operated potentiometer used for matching the amplification of the amplifiers to the sensitivity of the microphone. Once set it should not be touched unless the apparatus has been out of use for some time or a marked change in temperature has taken place, and then only when a calibration check indicates that it is necessary.

LIGHT.

This button controls the light on the meter scale. In order to save the batteries it is spring loaded so that the meter scale is illuminated only when the button is kept depressed.

FILTER INPUT, FILTER OUTPUT.

These sockets are for connection to the terminals of an external filter when the instrument is used for frequency analysis. The output impedance of the first amplifier at the EXT. FILTER IN socket is 25 ohm. The input impedance of the second amplifier at the EXT. FILTER OUT socket is 146 kohm in parallel with 45 pF.

OUTPUT.

This socket can be connected to a tape recorder or level recorder when measurements are to be recorded for later evaluation. It takes the cable AO 0007 (plug JP 0006). The load impedance should be at least 10 kohm. Maximum output voltage (for full scale deflection on the meter) is 3 V RMS. Maximum peak value 10 V.

The Octave Filter Set.

A sketch of the Octave Filter Set is given in Fig. 4.2.

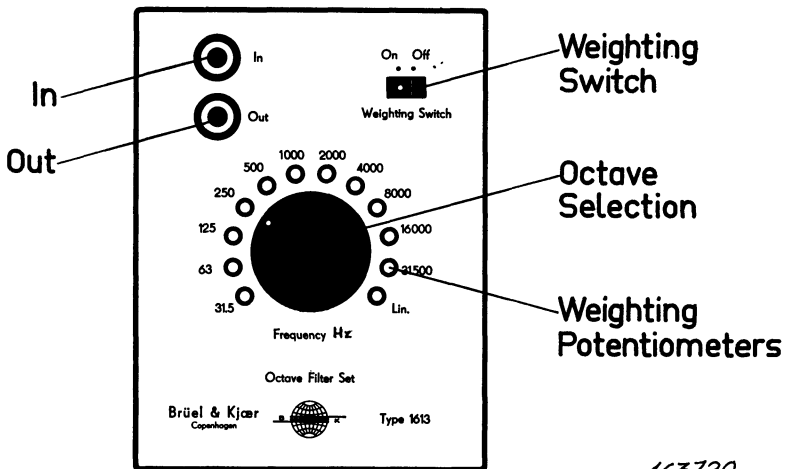

Fig. 4.2. The Octave Filter Set Type 1613.

IN and OUT.

These sockets are for connection to the Sound Level Meter external filter sockets via the Connection Bar JP 0400 or to other equipment via cables AO 0034 or AO 0035. These sockets, like those on the Sound Level Meter take B & K coaxial plugs JP 0006.

OCTAVE SELECTION.

This knob is used for selecting the required octave filter. The numbers indicate pass-band centre frequency.

WEIGHTING POTENTIOMETERS.

These potentiometers are screwdriver operated and are used to give different attenuation in each pass-band when the WEIGHTING SWITCH is in position "On".

WEIGHTING SWITCH.

When this is set to "Off" the weighting potentiometers are out of action.

Calibration Checks.

Calibration checks are carried out now and then in order to make sure that the instrument is working properly. Such checks are necessary when the apparatus has been out of use for a long time, or when ambient conditions have changed considerably. First check the condition of the batteries as follows: —

Pull out KNOB 1 and set to position "Batt.". The meter pointer should

now deflect to within the area marked "Battery". If it does not, replace the batteries. To do this unscrew the battery compartment cover at the end of the instrument. Remove the centre cell followed by the other two and clean out all dust and corroded material with a soft rag. Never use abrasives as this will damage the gold plating on the battery contacts. Replace the batteries, centre cell last, with three Mallory RM42K (or three ordinary 1.5 V torch batteries).

To check the amplifiers and meter circuit proceed as follows:—

Set KNOB 1 to position "Lin" and turn KNOB 3 fully clockwise. Turn KNOB 2 fully anticlockwise so that the "Ref" mark appears in the red circle to the right. The meter pointer should now deflect to a value on the upper red scale equal to the K-value of the microphone, obtained from the microphone calibration chart. If it does not, adjust the sensitivity by means of the sensitivity potentiometer until said condition is obtained. Note: The instrument should warm up for about 20 seconds before calibration.

The Sound Level Meter is now ready for use. See also Chapter 7 for acoustical calibration of the instrument. In cases when a 1/2" microphone is used with the instrument, the "Ref." deflection should be adjusted to zero on the meter scale and the K-value added to the measured sound levels. The K-value is found from the calibration chart supplied with each microphone.

Measurement of Sound.

When measuring sound the Sound Level Meter is used as follows: —

1. Pull out KNOB 1.
2. Check the instrument as outlined under "Calibration Checks".
3. Set KNOB 1 to position "Lin".
4. Rotate KNOB 2 clockwise until a meter deflection between 0 and 10 dB is obtained.
5. Set KNOB 1 to the desired function.
6. If necessary, rotate KNOB 3 counterclockwise to obtain a deflection between 0 and 10 dB. Note: Do not use KNOB 2 at this stage, in order not to overdrive the input amplifier. The reading on the meter scale together with the value shown in the red circle gives the result of the measurement.

Always state which weighting network has been used when quoting sound levels, e.g. 60 dB (A) or 58 dB (B). It will be clear from a study of Fig. 1.3 that the difference between A and C readings is a rough measure of the low frequency content of the signal investigated. The choice of curve to be used is left to the decision of the operator who should appreciate the particular requirements of the noise problem in hand.

Measurement of Vibration.

The Precision Sound Level Meter Type 2203 fitted with the Integrator and the Octave Filter Set Type 1613 is an excellent tool especially for on site vibration control and other investigations where portable equipment is required. Using a Brüel & Kjær accelerometer and a small fixing magnet (delivered with the accelerometer) measurements are carried out quickly and effectively at many points in a short time. Effects of changing vibration isolators, speed of shaft rotation etc. are readily found. Addition of the Filter Set makes possible a frequency analysis of the vibration which is of great help when corrective measures are to be decided upon, as the type of for example a vibration isolator to be used depends upon the frequency of the vibration.

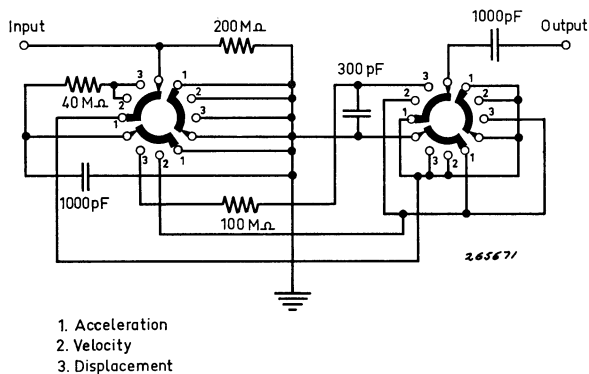

Fig. 4.3. Circuit diagram for the Integrator ZR 0020.

The Integrator, containing two stages of integration, is designed for screwing directly onto a B & K Precision Sound Level Meter Type 2203, effectively converting this into a handy, portable vibration meter, capable of indicating levels of acceleration, velocity and displacement when an acceleration pick-up is employed as a vibration transducer. A slide rule is delivered with the Integrator which may be set to the acceleration pick-up sensitivity and used for direct conversion of dB-readings to units of vibration (metric and British). Accelerometer sensitivities from 10 to 1000 mV/g are covered.

The components of the RC integrating networks have been chosen to give a low-frequency cut-off (-3 dB point) at about 5 Hz. This is sufficiently low, since the Precision Sound Level Meter itself has a low-frequency cut-off in the same region. The high-frequency limits are determined by the capacitive coupling between input and output and are about 10 kHz for velocity and 4 kHz for displacement measurements. These ranges are sufficiently large for the majority of applications. Frequency response curves for the Integrator set to "Acceleration", "Velocity" and "Displacement" with the Precision Sound Level Meter as indicator are given in Fig. 4.4.

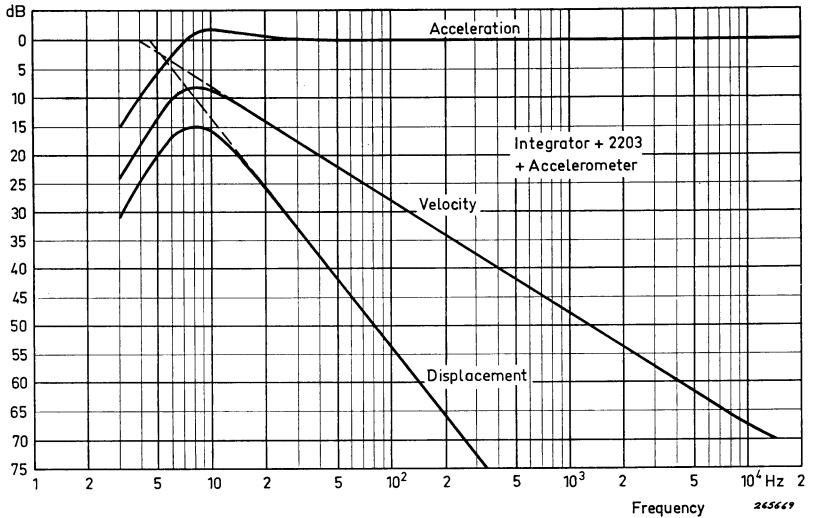

Fig. 4.4. Frequency response curves for the Integrator used with the Precision Sound Level Meter Type 2203. (From Serial No. 137745).

Operation.

The following procedure should be adopted when measuring with the Integrator.

1. Adjust the instrument for a K-factor of 0 as outlined under "Calibration Checks".

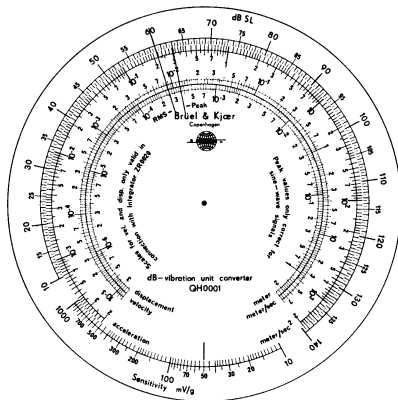

Fig. 4.5. The Slide Rule set to an accelerometer sensitivity of 50 mV/g and an instrument reading of 60 dB.

2. Connect the accelerometer lead to the integrator and set to the quantity which is to be measured, e. g. acceleration, velocity or displacement.
3. Read the vibration level in dB (sound level) on the indicating instrument.
4. Set the slide rule to the correct accelerometer sensitivity in mV RMS/g RMS.
5. Set the cursor to the number of dB read on the meter and read off the corresponding RMS acceleration, velocity or displacement. The peak value may be read only in the case of sinusoidal vibration.

Note that the slide rule can not be used for conversion of for example acceleration to velocity. Each scale must only be used in connection with the appropriate setting of "Acceleration", "Velocity" or "Displacement" on the Integrator.

The slide rule for the Integrator is shown in Fig. 4.5, where it is set to an accelerometer sensitivity of 50 mV/g. With the integrator set to "Velocity" a reading on the Sound Level Meter of 60 dB gives a value of about 8.7×10^{-3} meter/sec for the vibration velocity.

Specifications ZR 0020.

Frequency Response with 2203, using Accelerometer with capacity 1000 pF.

Velocity 10 Hz — 10 kHz \pm 1.5 dB. (20 Hz — 10 kHz for 2203 with Serial Number lower than 137745)
25 Hz — 5 kHz \pm 0.5 dB

Displacement 20 Hz — 4 kHz \pm 1.5 dB
50 Hz — 2 kHz \pm 0.5 dB

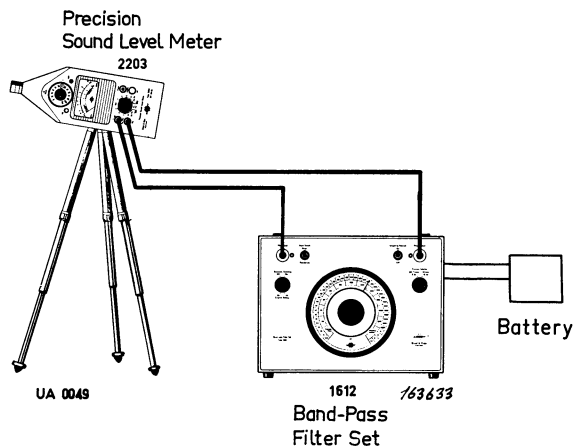

Fig. 4.6. The Sound Level Meter used with the Band Pass Filter Set Type 1612.

Temperature Coefficients

Velocity, + 0.02 dB/°C

Displacement + 0.04 dB/°C

Use of External Filters.

The Sound Level Meter may be used in conjunction with external filters such as the Octave Filter Set Type 1613 or the Band-Pass Filter Set Type 1612 containing both octave and 1/3 octave filters. The Octave Filter Set Type 1613 may be joined to the Sound Level Meter to make a portable sound and vibration analyzer. To connect the Band-Pass Filter Set Type 1612 two cables AO 0007 are employed. The Type 1612 requires a DC voltage of 9 V which can be supplied from a small battery.

When external filters are employed the instrument is operated as described under "Measurement of Sound" on page 21, except for Item 5 which should read: Set KNOB 1 to "Ext. Filt."

5. Accuracy of Measurements

The Condenser Microphone.

The sensitivity of the 1" Condenser Mncrophone Type 4131 which is normally supplied with the Sound Level Meter is approximately 5 mV/ μ bar and it has a linear frequency response from 20 Hz to 18 kHz to within ± 2 dB at 0° incidence. From 20 Hz to 15 kHz the response is linear to within ± 1 dB. Each microphone is supplied with a calibration chart giving a complete

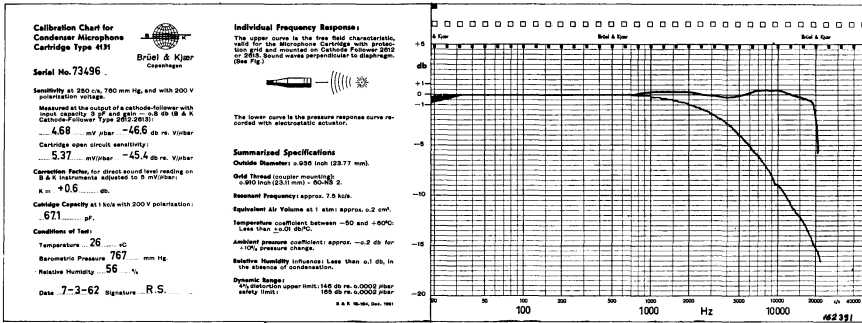

Fig. 5.1. Typical calibration chart as supplied with the microphone cartridges. The automatic plotting process used in production has an accuracy of 0.2 dB up to 10 kHz and 0.5 dB up to 20 kHz.

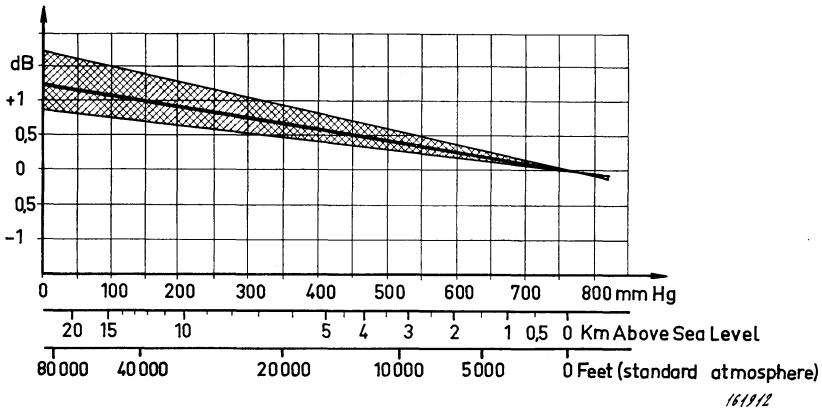

Fig. 5.2. Microphone sensitivity at 400 Hz as a function of the static ambient pressure. The corresponding altitudes are also given on the curve.

technical specification and an individually obtained frequency response curve as shown in Fig. 5.1.

The upper curve is the free field response which applies when the microphone is used for ordinary sound level measurements. The lower curve, which is the pressure response of the microphone, applies for measurements in small closed volumes with dimensions so small that essentially no wave motion takes place, as for example a 6 cm³ coupler for earphone measurements.

To ensure high operating stability under varying conditions of temperature and humidity the microphone diaphragm and housing are made of materials having identical temperature coefficients of expansion, and the back plate is insulated from the housing by means of silicone treated quartz, giving the highest possible leakage resistance in areas of high relative humidity. The microphone as well as the amplifiers are unaffected by humidity as long as no condensation takes place within the instrument. The change in microphone sensitivity due to variations in ambient pressure and temperature can be seen from Figs. 5.2 and 5.3.

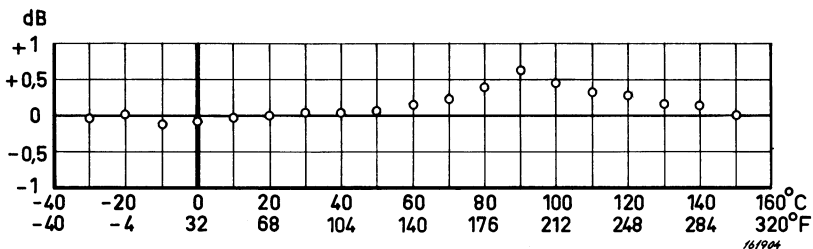

Fig. 5.3. Variation of microphone sensitivity with temperature at 400 Hz.

As the amplifier and meter circuit can be checked by means of an internal calibration signal, the important factor is the stability of the microphone, and as shown above, the microphone is almost unaffected by environmental conditions.

The Amplifiers.

The amplifiers are insensitive to variations in temperature. Within the range 15° to 45° C the amplification does not vary noticeably, and as shown in Fig. 5.4 the change is less than ± 1 dB in the range 10° to 60° C.

The extensive use of transistors requires that the instrument should not be subjected to more than 75° C for long periods of time, although it will stand 90° C for some 200 hours without damage to anything but the batteries. Below -10° to -15° C the instrument becomes inoperative.

The Meter.

The meter is calibrated at a temperature of about 20° C but may show a slight variation due to the temperature characteristic of the diodes in the rectifier circuit. This variation does not, however, exceed 0.4 dB in the temperature range of normal use.

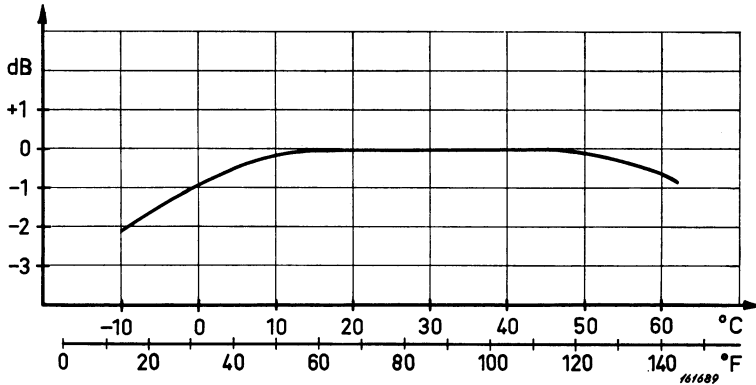

Fig. 5.4. Amplification versus temperature for the amplifier.

Calibration Signal.

The calibration signal for the amplifiers and meter circuit is obtained from a stabilized 1 kHz supply used also for the microphone polarization voltage. The signal is well stabilized both for variations in battery voltage and for changes in temperature. Fig. 5.5 shows the variation in signal voltage with temperature. When the calibration signal increases due to temperature, the sensitivity of the input amplifier will be reduced when calibration is carried out. At the same time the sensitivity of the microphone increases due to increase in polarization voltage, so that the net result is a very slight or no change in overall sensitivity of the instrument.

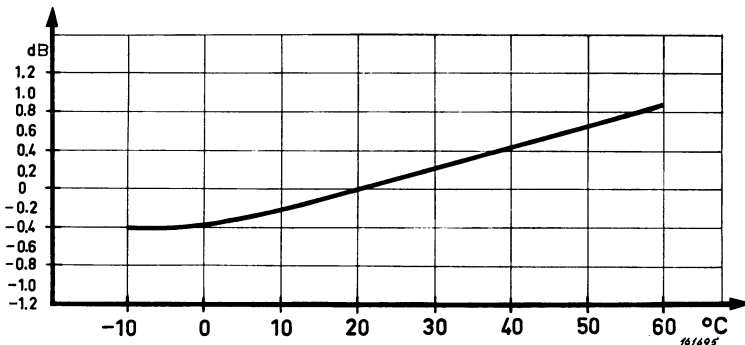

Fig. 5.5. The variation in calibration voltage as a function of temperature.

Power Supply.

Because of possible variations in battery voltage a stabilization circuit is inserted before the 1 kHz oscillator which transforms the DC voltage from the batteries into the required voltage levels.

Weighting Networks.

The weighting networks contained in the Precision Sound Level Meter are made to the tolerances Recommended by I.E.C. for precision sound level meters. These tolerances apply to the functioning of the whole apparatus in a

Frequency Hz	Curve A dB	Curve B dB	Curve C	Tolerance limits dB	
10	-70.4	-38.2	-14.3	5	-∞
12.5	-63.4	-33.2	-11.2	5	-∞
16	-56.7	-28.5	-8.5	5	-∞
12.5	-50.5	-24.2	-6.2	5	-5
25	-44.7	-20.4	-4.4	5	-5
31.5	-39.4	-17.1	-3.0	3	-3
40	-34.6	-14.2	-2.0	3	-3
50	-30.2	-11.6	-1.3	3	-3
63	-26.2	-9.3	-0.8	3	-3
80	-22.5	-7.4	-0.5	2	-2
100	-19.1	-5.6	-0.3	1	-1
125	-16.1	-4.2	-0.2	1	-1
160	-13.4	-3.0	-0.1	1	-1
200	-10.9	-2.0	0	1	-1
250	-8.6	-1.3	0	1	-1
315	-6.6	-0.8	0	1	-1
400	-4.8	-0.5	0	1	-1
500	-3.2	-0.3	0	1	-1
630	-1.9	-0.1	0	1	-1
800	-0.8	0	0	1	-1
1000	0	0	0	1	-1
1250	0.6	0	0	1	-1
1600	1.0	0	-0.1	1	-1
2000	1.2	-0.1	-0.2	1	-1
2500	1.3	-0.2	-0.3	1	-1
3150	1.2	-0.4	-0.5	1	-1
4000	1.0	-0.7	-0.8	1	-1
5000	0.5	-1.2	-1.3	1.5	-1.5
6300	-0.1	-1.9	-2.0	1.5	-2
8000	-1.1	-2.9	-3.0	1.5	-3
10000	-2.5	-4.3	-4.4	2	-4
12500	-4.2	-6.1	-6.2	3	-6
16000	-6.6	-8.4	-8.5	3	-∞
20000	-9.3	-11.1	-11.2	3	-∞

Table 5.6. Free Field Frequency Response of Precision Sound Level Meters in dB, relative to the response at 1000 Hz when Weighting Networks are inserted.

free sound field for normal incidence of the sound waves. The calibration is valid only when the operator has a negligible influence on the sound field at the position of the microphone, i.e. the instrument must be held as far in front of the operator as possible, or preferably a microphone extension cable should be used.

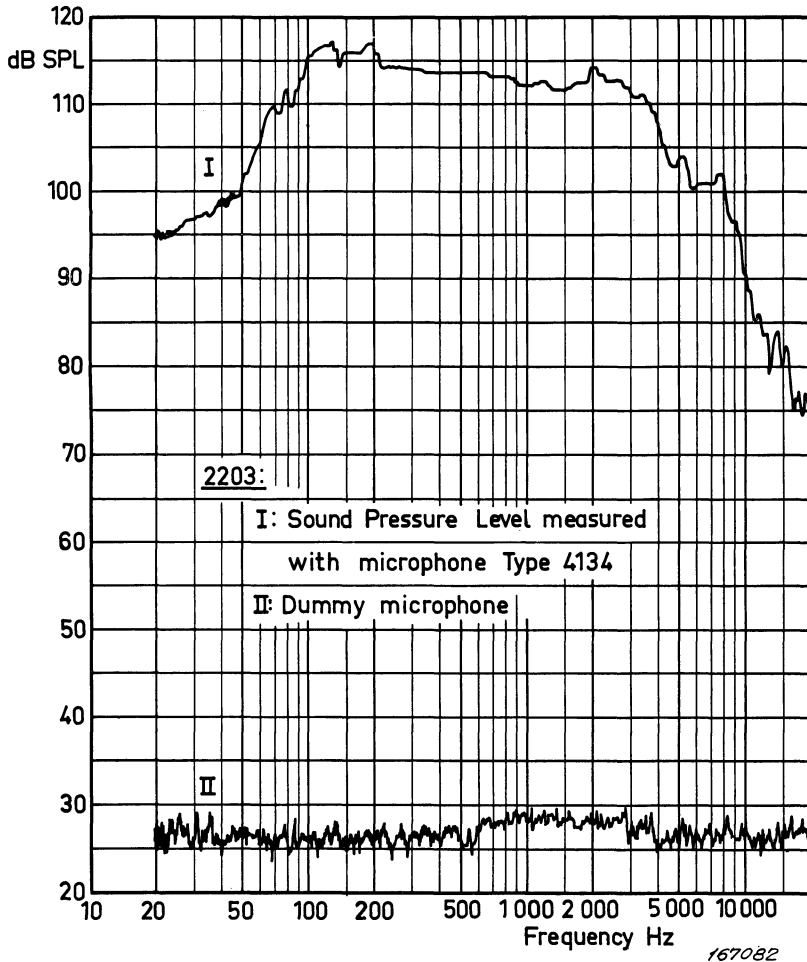

Fig. 5.7. The Sound Level Meter exposed to a sound field of approximately 120 dB. Curve I shows the sound pressure level, and curve II shows the output of the Sound Level Meter when the microphone was replaced with an equivalent impedance.

From instrument Serial No. 82939 the Type 2203 meets the American Standards Specification for General Purpose Sound Level Meter, ASA S1.4-1961. Since random incidence is specified in this standard a Random Incidence Corrector UA 0055 must be fitted to the microphone. Also the German Standard; DIN 45633 is fulfilled. The table Fig. 5.6 gives the tolerances Recommended by IEC.

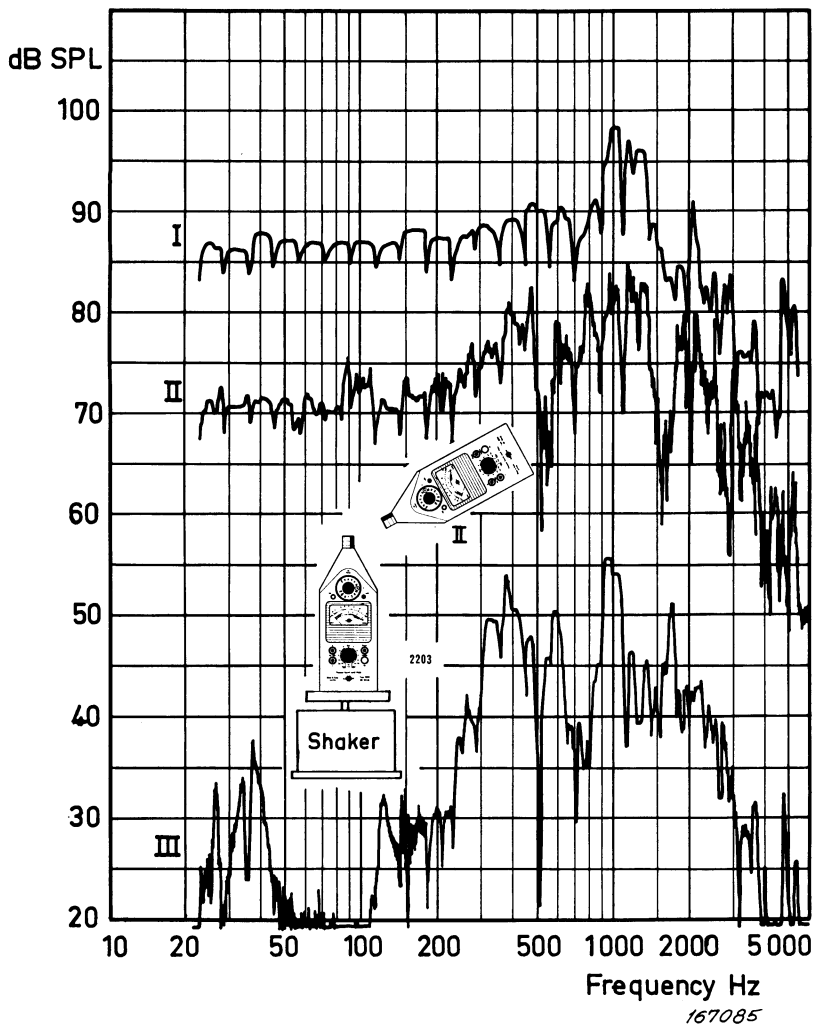

Fig. 5.8. (See p. 33).

Effects of Vibration and Sound.

Fig. 5.8 shows the effect of vibration upon the instrument in terms of the equivalent sound pressure level and Fig. 5.7 shows the output from the Sound Level Meter when exposed to a sound field of approximately 120 dB and with the microphone replaced by an equivalent sound insensitive capacitor.

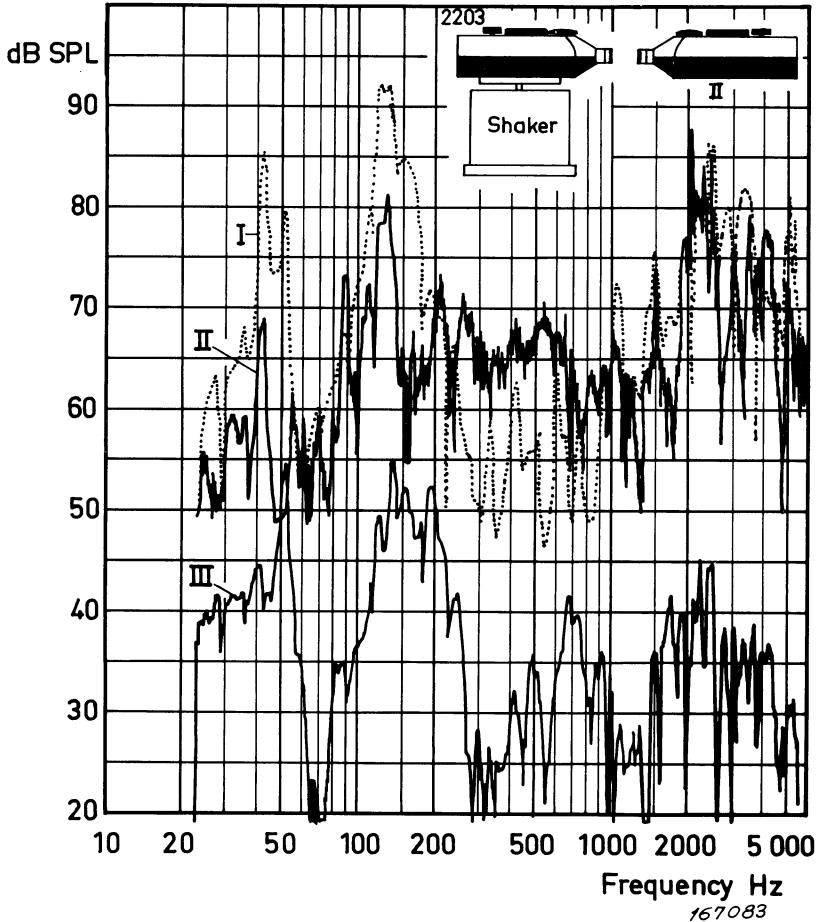

Fig. 5.8. The above curves show the effect of vibration upon the Sound Level Meter. The instrument is excited in three different directions as shown, and the acceleration is kept constant at 1 g. The curves marked I are obtained with the microphone in place, while the curves marked III are obtained with the microphone replaced by an equivalent sound and vibration insensitive impedance. The curves marked II gives the sound pressure developed by the Shaker measured with another Sound Level Meter Type 2203 (II).

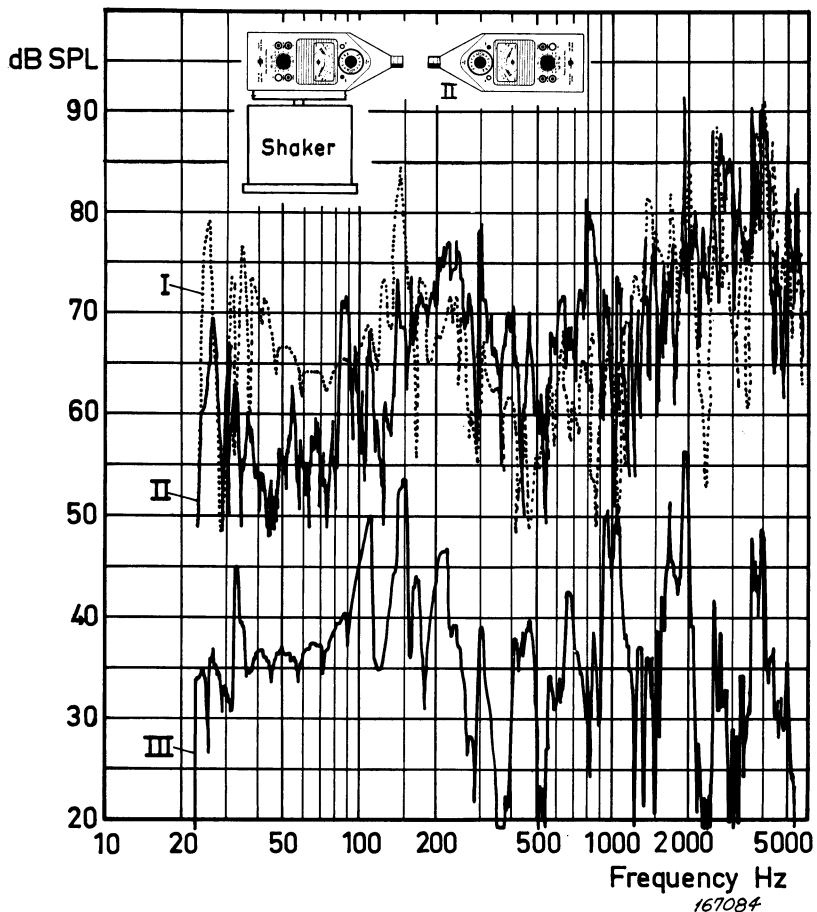

Fig. 5.8. (Continued).

Effects of Electric and Magnetic Fields.

The sensitivity to electrostatic fields is extremely low when the protection grid is mounted on the microphone. The sensitivity to magnetic fields is approximately $3 \text{ mV} = 70 \text{ dB}$ sound pressure level for a field strength of 50 oersted at 50 Hz.

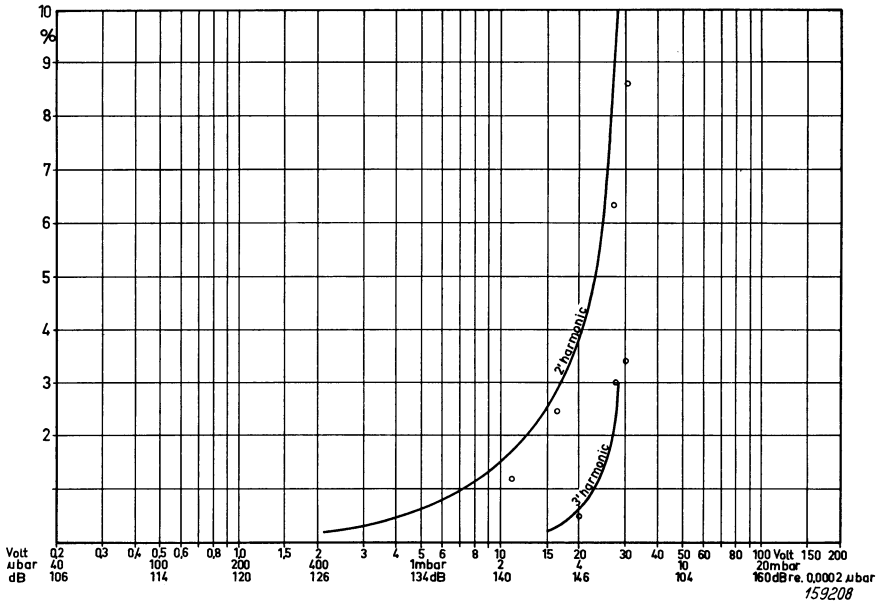

Fig. 5.9. Typical distortion curves for the one-inch microphones.
The curves in full are measured on the source-follower and referred to a complete microphone with a sensitivity of 5 mV/ μ bar. The measuring points shown are averages measured in a pistonphone on a number of complete microphones at 50 Hz.

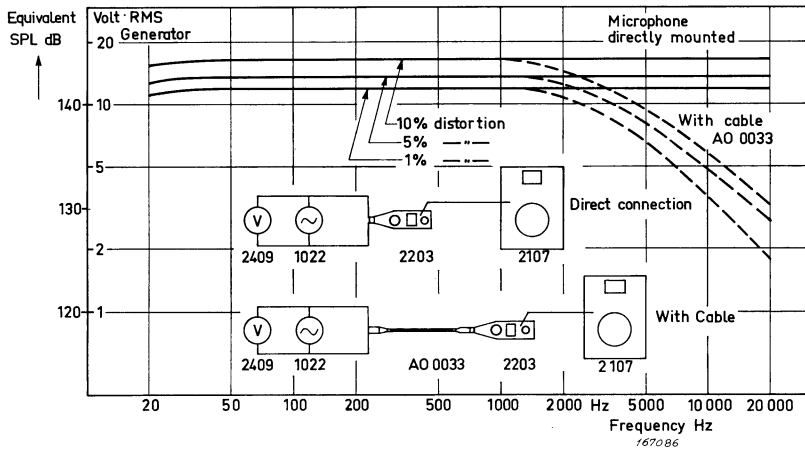
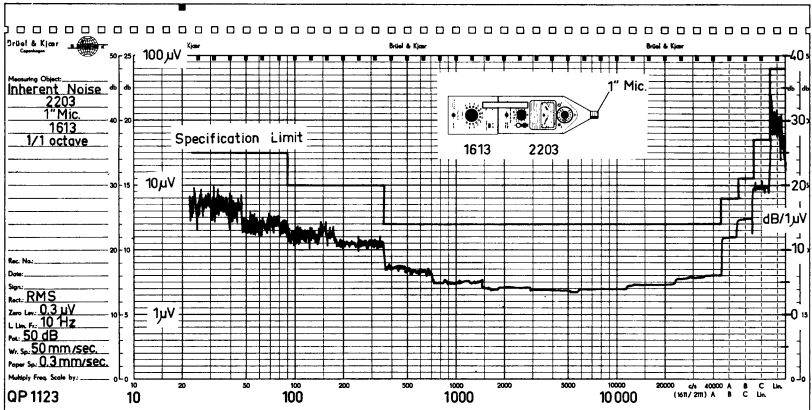
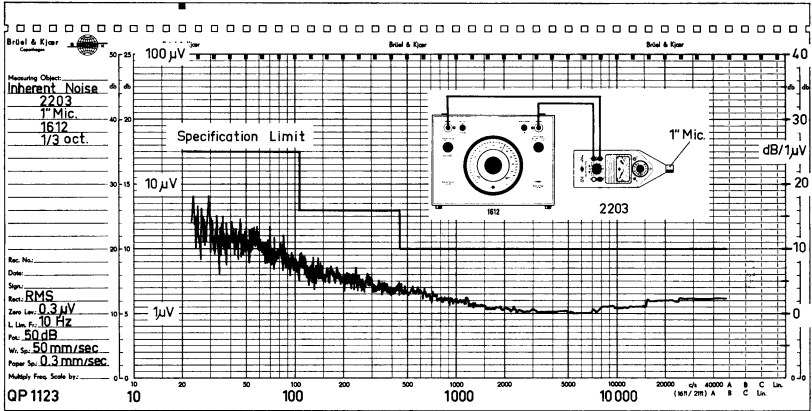
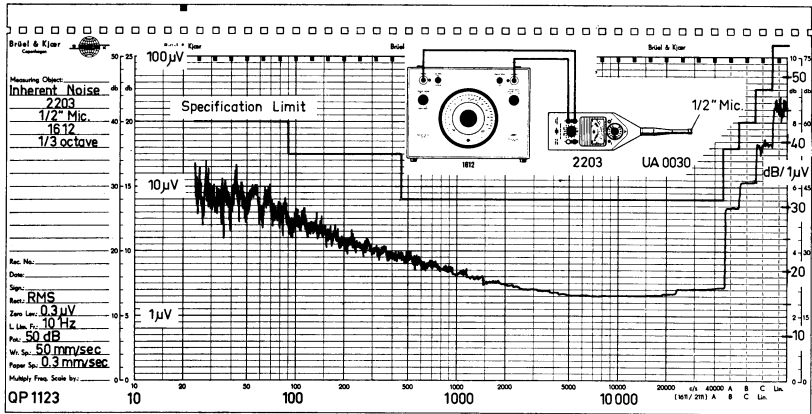

Fig. 5.10. Distortion originating in the source-follower and amplifier circuits.

Distortion.

Distortion, both from the microphone and from the circuitry, sets an upper limit to the useful range of the instrument. Fig. 5.9 shows some typical distortion curves for the one inch microphone normally supplied with the Sound Level Meter, and Fig. 5.10 gives the distortion originating in the source-follower and amplifier circuits.





(c)

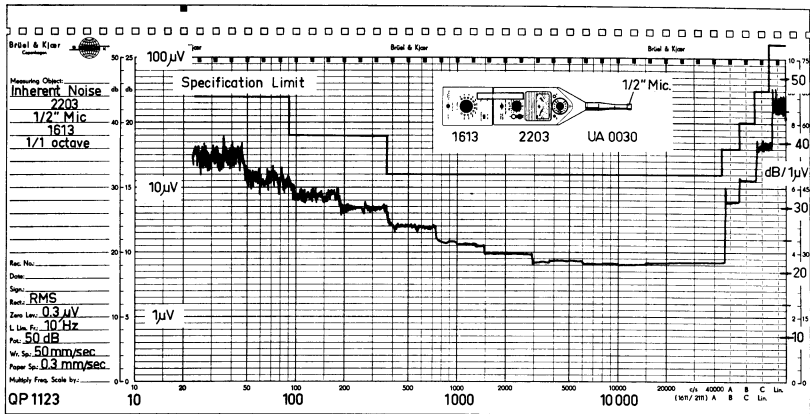

(d)

Fig. 5.11. Inherent noise level spectrograms for the Sound Level Meter.

Inherent Noise Levels.

The lower limit of measurement is governed by the inherent noise level of the Sound Level Meter itself. This depends on which weighting network or filter is inserted.

Fig. 5.11 gives the inherent noise levels for the Sound Level Meter both with 1" and 1/2" microphones. The noise was measured in octave and 1/3 octave bands.

6. Operating Characteristics

Directional Characteristics.

Ideally a sound level meter should have the same sensitivity for sound coming in from all directions. Unfortunately this can not be achieved in practice except in the case of relatively low frequencies because of the size of the instrument on which the microphone is mounted or the size and shape of the microphone itself.

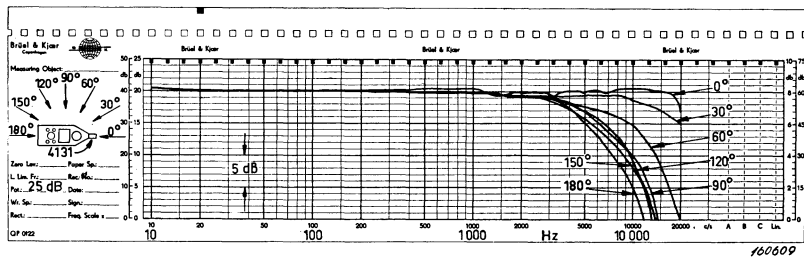

Fig. 6.1. Frequency response of the Sound Level Meter for different angles of incidence. The instrument was equipped with microphone Type 4131, which is normally used.

For higher frequencies, when the dimensions of the sound level meter are comparable to the wavelength of the sound, the sound field around the instrument will be disturbed and the pressure on the microphone diaphragm will depend on the direction from which the sound is coming.

The directional properties of the Sound Level Meter Type 2203 are seen from Fig. 6.1, which shows the frequency response for sounds coming in from different angles. As shown the variation in frequency response for varying angle of incidence is negligible for frequencies below approximately 3 kHz, while at higher frequencies the change in response is considerable.

When taking sound level measurements the operator usually knows the source of the sound and automatically points the sound level meter in this direction. Consequently the directional characteristics of the instrument are not so important. Sometimes however it may be necessary to pay special attention to these characteristics because:—

- a) Noise, even from a point source, measured in a room with hard boundaries undergoes many reflections so that the sound field is more or less diffuse.

- b) The sound often originates from many sources simultaneously, take for example a machine shop.
- c) Angle of incidence may vary during measurement, for example as a car passes or an aeroplane flies overhead.

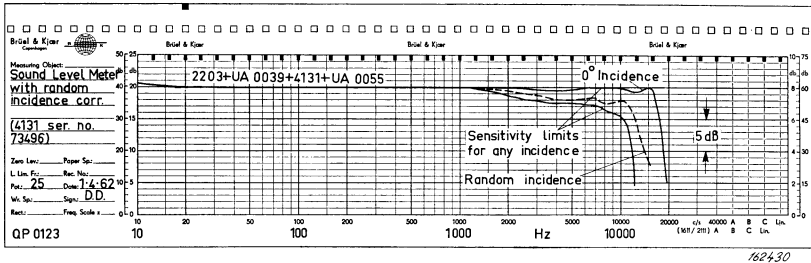

Fig. 6.2. Frequency response of the instrument using a 4131 microphone with Random Incidence Corrector and Extension Rod.

In all these cases it is desirable that the sensitivity of the measuring instrument should not vary too much with angle of incidence. Therefore when the sound contains important high frequency components it may be necessary to improve the directional characteristics of the Sound Level Meter. This may be done in several ways:—

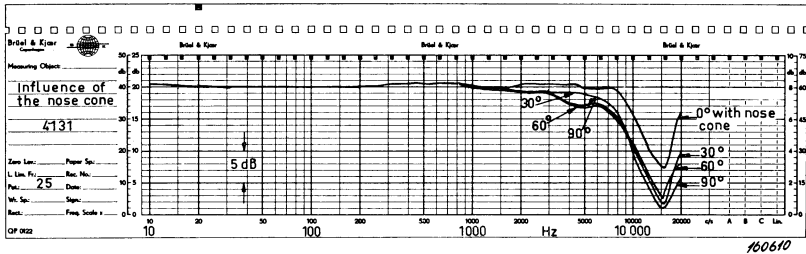

Fig. 6.3. Frequency response for various angles of incidence when Nose Cone UA 0051 is employed. (Microphone Type 4131).

1. Use an Extension Connector UA 0039 and replace the microphone protection grid with a Random Incidence Corrector Type UA 0055. This gives the instrument improved directional characteristics as shown in Fig. 6.2. A so-called “random incidence curve” is also shown which has been calculated from the sensitivities for several well-defined angles of incidence in accordance with the formula recommended by the I.E.C.

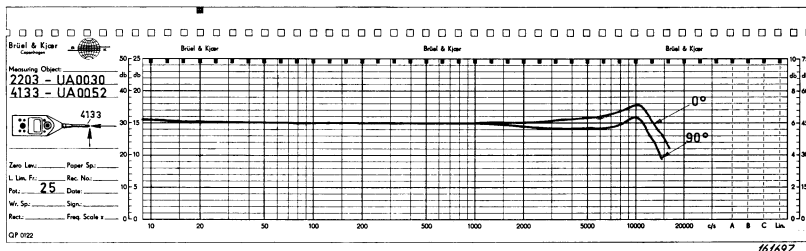

Fig. 6.4. Frequency response curves of the instrument when employing the Microphone Type 4133 with Nose Cone UA 0052.

(Publication No. 123), and effectively gives the microphone response in a diffuse sound field.

2. Another solution is to use a Nose Cone Type UA 0051 in place of the microphone protection grid. See Fig. 6.3. The Nose Cone is primarily designed to reduce wind noise, and for improving omnidirectivity it is not as effective as the Random Incidence Corrector.
3. The omnidirectivity of a smaller microphone extends to higher frequencies than that of a larger microphone. Consequently good high frequency characteristics are obtained by fitting a 1/2" microphone to the Sound Level Meter. This involves the use of Adaptor UA 0030. Still further improvements are obtained when using the Nose Cone UA 0052 with the 1/2" microphone. The directional characteristics thus obtained are shown in Fig. 6.4. Note that the sensitivity of the 1/2" microphones is approximately 1 mV/ μ bar, so that when the 1" microphone is replaced by a 1/2" microphone a K-value of approximately 14 dB must be added to the Sound Level Meter reading.
4. Certain arrangements have optimum response for 90° incidence, and sometimes it may be possible to arrange that all the sounds measured have 90° incidence. This is the case when the microphone diaphragm is in a horizontal plane so that all sounds reach it tangentially.

Notes on Reflection.

The precise measurement of sound with portable instruments is sometimes hampered by reflections from the operator and also from the instruments themselves. When the sound field is diffuse or when the sound consists of many frequencies this presents no problem and the results obtained will only depend on the accuracy of the instrumentation. However when the sound waves are planar and the sound consists of one or two single frequencies there is a possibility of considerable reflections and consequent build-up of sound pressure.

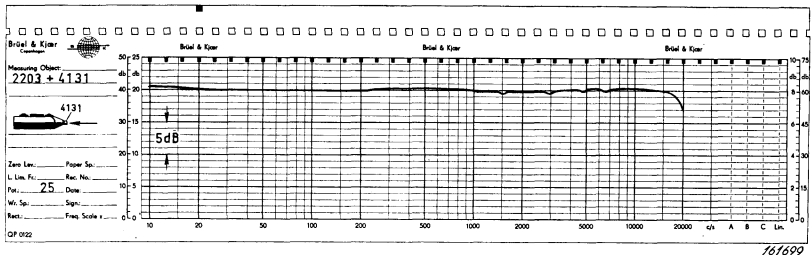

Fig. 6.5. Frequency response of the instrument with microphone Type 4131.

Investigations have been carried out in order to determine the influence of sound wave reflections from instrument housings of different shapes, and also from a person standing behind the instrument. Fig. 6.5 shows the response of the Sound Level Meter with no disturbing obstacles nearby. The slight irregularities that appear on the curve are due to reflections from the knobs and meter housing. Anomalies due to reflections from the operator are usually most marked in the frequency range 200 to 4000 Hz. Errors in the order of 2—3 dB may easily result, and around 400 Hz more than 10 dB may be experienced. (An excellent treatment of this rather complicated subject of reflections has been published by R. W. Young in the journal "Sound", Vol. 1, 1962, page 17.)

Whether the presence of the operator has any influence on the sound level reading or not can be detected by changing the relative position of the

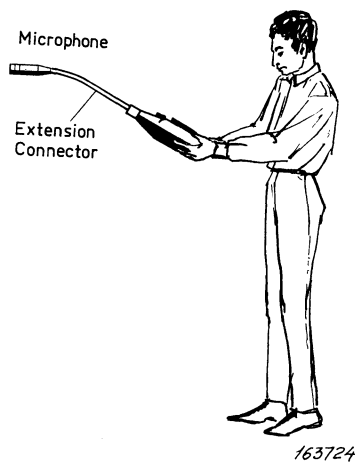

Fig. 6.6. Sound Level Meter with Extension Connector.

operator and the instrument, say by holding the Sound Level Meter to one side and observing any change in meter deflection. For the majority of noise measurements there will be no difference in meter reading, but as explained above, in the case of essentially plane acoustic waves of single frequencies, reflections may cause build-up of sound pressure or standing waves, giving increase or decrease in meter reading. For precise measurements it will therefore be necessary to arrange for the microphone to be placed some distance away from the operator so that the sound field at the point of measurement is not disturbed by his presence. This may be done in two different ways:—

1. The microphone may be separated from the Sound Level Meter by using an Extension Cable or Extension Connector as shown in Fig. 6.6.
2. The whole instrument may be separated from the operator by using a separate indicating instrument connected to the OUTPUT terminals of the Sound Level Meter. Suitable indicating instruments are the Electronic Voltmeter Type 2409 or the Level Recorder Type 2305. See Fig. 6.7.

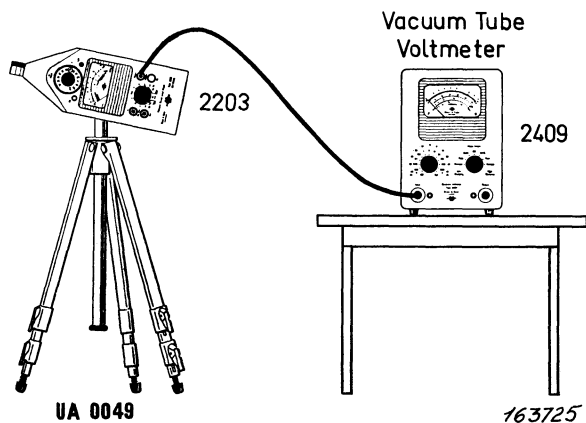

Fig. 6.7. Voltmeter used as indicating device.

Conclusions.

For common sound level measurements of machine noise, traffic noise etc. when the direction of the sound is well defined, the Precision Sound Level Meter Type 2203 equipped with a 1" microphone gives correct readings of the sound level according to existing standards.

In the very few cases of plane acoustic waves of single frequencies it is necessary to use an Extension Connector or Extension Cable in order to remove the microphone away from the influence of the operator. Alternative-

ly a separate indicating instrument may be used connected to the OUTPUT of the Sound Level Meter.

When the sound comes from all directions it may be necessary to use a Random Incidence Corrector and an Extension Connector in order to obtain a better omnidirectivity.

Equipped with an Extension Connector and a 1/2" microphone the instrument meets all the requirements of the I.E.C. recommendation for precision sound level meters as well as the American standard, provided that the system is properly calibrated, e.g. with a pistonphone. See p. 45.

Influence of Background Noise.

If it is required to measure the sound emitted from a particular piece of equipment, e.g. an electric motor, best results would be obtained by removing the motor and carrying out the measurements in an anechoic room with no disturbing background noise. However, this is not always possible, and the measurements have to be done with the background noise present.

If the background sound level with the motor switched off is much lower than the sound level with the motor running, no correction is required, but if the

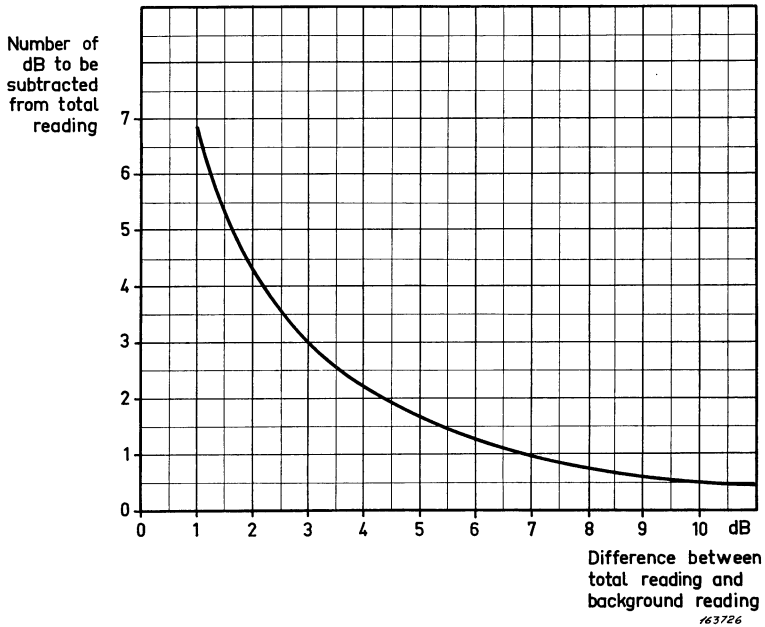

Fig. 6.8. Background correction.

difference is less than about 10 dB it is necessary to correct for background noise. A graph is given in Fig. 6.8 of the dB value to be subtracted from the total reading for different values of background sound level.

When the difference between total reading and background level is more than 2—3 dB this method is accurate enough for most purposes. However, when smaller differences are measured, the motor noise must be measured in an anechoic room, or the background sound level must be reduced.

7. Methods of Calibration

From time to time it may be necessary to make an acoustical calibration of the Sound Level Meter in addition to the built-in electrical calibration of the amplifiers and meter circuit. Brüel & Kjær produce two different acoustical calibrators for use with the Sound Level Meter. Both are easily portable and can be used in the field.

The Noise Source Type 4240.

The Noise Source is a small mechanical-acoustical device producing an approximately white noise spectrum of gaussian amplitude distribution. It is easily mounted on the microphone as shown in Fig. 7.1, and gives a sound level of approximately 108 dB at the microphone diaphragm. The actual value is written on each Noise Source as they are individually calibrated at the factory. Accuracy of calibration using the Noise Source: ± 1.5 dB.

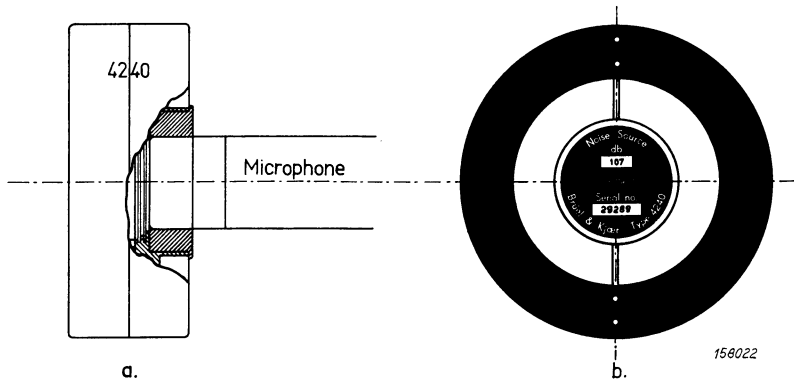

Fig. 7.1. Sketch showing the Noise Source correctly placed on the Microphone.

The Pistonphone Type 4220.

In order to meet the IEC specification for precision sound level meters, an overall measuring accuracy of ± 1 dB is required. It is therefore necessary, when precision measurements are carried out, to calibrate the whole apparatus including the microphone under the conditions of actual measurement. All errors due to temperature, pressure and humidity, tolerances on microphone sensitivity, cable attenuation etc. are then automatically reduced to zero.

Such a calibration can be carried out on the B & K microphones using the B & K Pistonphone Type 4220. After calibration it is possible to perform sound level measurements to an accuracy of ± 0.3 dB with the Precision Sound Level Meter Type 2203.

The principle of operation of the Pistonphone is shown in Fig. 7.3.

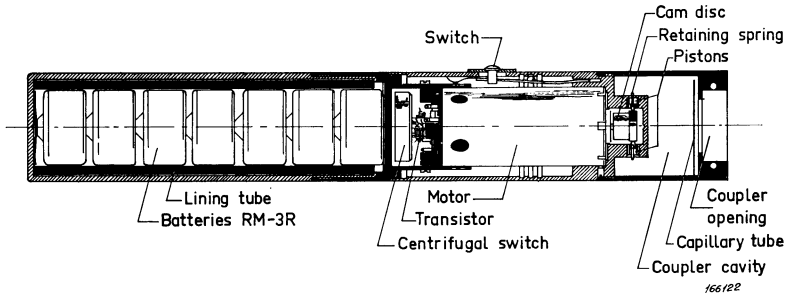

Fig. 7.2. Assembly drawing of the Pistonphone.

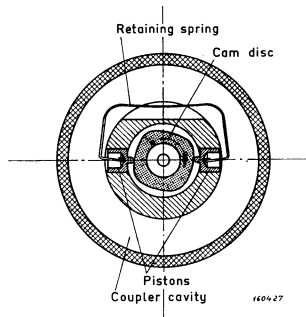

Fig. 7.3. Cross-section showing the principle of operation.

The two pistons are driven symmetrically by means of a cam disc, mounted on the shaft of a battery driven miniature electric motor. The cam, which is made of specially selected, tempered steel and machined to a high degree of accuracy, gives the pistons a sinusoidal movement at a frequency equal to four times the speed of rotation. The cavity volume is therefore varied sinusoidally and the RMS sound pressure produced will be

$$p = \gamma P_0 \frac{2 A_p S}{V \sqrt{2}}$$

where $\gamma = C_p/C_v$ = ratio of specific heats for the gas in the cavity

P_0 = atmospheric pressure.

A_p = area of each piston.

- S = peak amplitude of motion of piston from mean position.
 V = volume of cavity with the pistons in the mean position + equivalent volume of the microphone.

The sound pressure level in dB produced at the microphone diaphragm is consequently

$$\text{S.P.L.} = 20 \log \frac{P}{p_0}$$

where p_0 is the reference pressure = $0.0002 \mu\text{bar}$.

The Pistonphone used with a 1" microphone produces a constant sound pressure level of 124 dB at 250 Hz. From the above formula can be seen that the only variable quantity is the ambient atmospheric pressure. A barometer is therefore supplied with the pistonphone, calibrated directly in dB to be added or subtracted from the value indicated on the pistonphone. The accuracy of calibration is ± 0.2 dB and distortion less than 3 %.

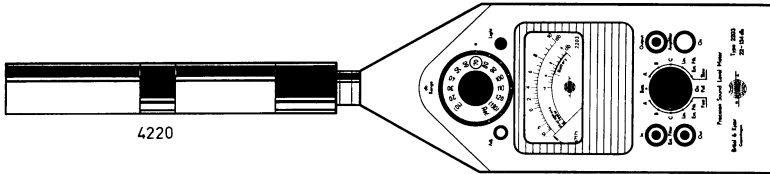

Fig. 7.4. Calibration of the Precision Sound Level Meter Type 2203.

To calibrate proceed as follows:

1. Place the Pistonphone on the Sound Level Meter as shown in Fig. 7.4 and switch to position "Measure". Make sure that the Pistonphone fits tightly to the microphone.
2. On the Sound Level Meter set KNOB 1 to "Lin." "Fast", KNOB 3 fully clockwise and adjust KNOB 2 until the figure 120 appears in the red circle. The meter should now indicate 4 dB (or 3.9 dB if the Pistonphone is calibrated to give 123.9 dB). If it does not, adjust the ADJ. potentiometer until correct deflection is obtained.

8. Accessories

The following is a list of accessories for use with the Precision Sound Level Meter and Octave Filter Set.

Integrator ZR 0020.

The integrator is a two-stage integration network making measurement of acceleration, velocity and displacement possible when the Sound Level Meter is used with an accelerometer type vibration pick-up. See section Measurement of Vibration, chapter 4.

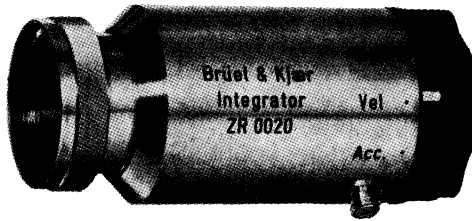

Fig. 8.1. Integrator ZR 0020.

Input Adaptor JJ 2612.

This adaptor facilitates the use of the Sound Level Meter as an indicator for

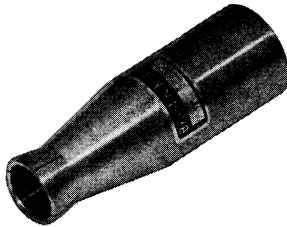

Fig. 8.2. Input Adaptor JJ 2612.

vibration measurements in conjunction with an accelerometer, or as a portable preamplifier for electrical signals in general. It takes a standard B & K coaxial plug JP 0018. When used with the Input Adaptor the Sound Level Meter has an input impedance of approximately 2 Gohm. JJ 2612 is supplied with the instrument.

Floor Stand UA 0049.

The floor stand is a portable tripod similar to those used for photographic work. It is used for supporting the Sound Level Meter (with Octave Filter Set) during long term measurements or when it is desirable to minimize effects of the operator on the sound field.

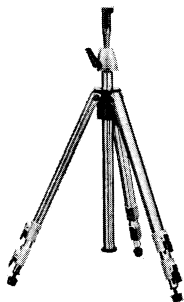

Fig. 8.3. Floor Stand UA 0049.

Adaptor UA 0030.

The Adaptor UA 0030 makes it possible to use a 1/2" microphone with the Sound Level Meter. This is necessary in cases where it is desired to obtain better high frequency response and omnidirectivity at higher frequencies than those obtained with the normal 1" microphone. Attenuation of the Adaptor: 0.1 dB.

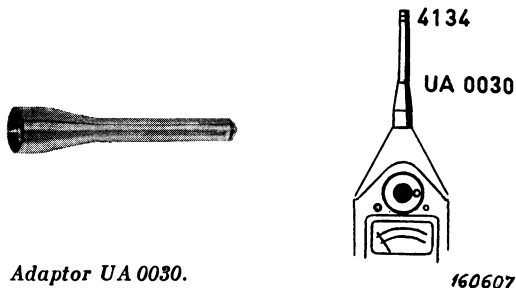

Fig. 8.4. Adaptor UA 0030.

Nose Cone UA 0051.

The Nose Cone can be used in place of the normal microphone protection grid in order to reduce wind noise e.g. during outdoor measurements. It also improves the omnidirectional properties of the microphone. With the Nose Cone mounted on the Sound Level Meter the variation in sensitivity with angle of incidence will be less than + 0 to - 4 dB at 8 kHz and + 0 to - 6 dB at 12.5 kHz when the angle of incidence is less than 90°.



Fig. 8.5. Nose Cone UA 0051.

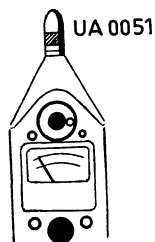

160608

Random Incidence Corrector UA 0055.

The Random Incidence Corrector screws onto the microphone in place of the protection grid. It makes precise measurements possible up to 10 kHz on sounds having variable or random incidence, when using the microphone supplied with the Sound Level Meter plus one of the extensions AO 0033 or UA 0039.

Without the Corrector any measurement involving high frequencies would be subject to error when investigations into noise from aircraft in flight, noise in workshops etc. are undertaken. For any angle of incidence the variation in sensitivity with the Random Incidence Corrector will be less than + 0 to - 4 dB at 8 kHz and + 0 to - 6 dB at 10 kHz.



Fig. 8.6. Random Incidence Corrector UA 0055.

Windscreen UA 0082.

The windscreen shields the microphone from low frequency wind noise and is used for outdoor measurements, in ventilation ducts etc. Fits all B & K microphones.

Correction curves for various angles of incidence with the Windscreen mounted on the Sound Level Meter are shown in Figs. 8.8 and 8.9.

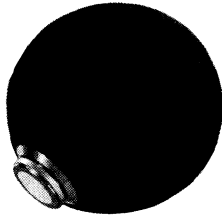

Fig. 8.7. Windscreen UA 0082.

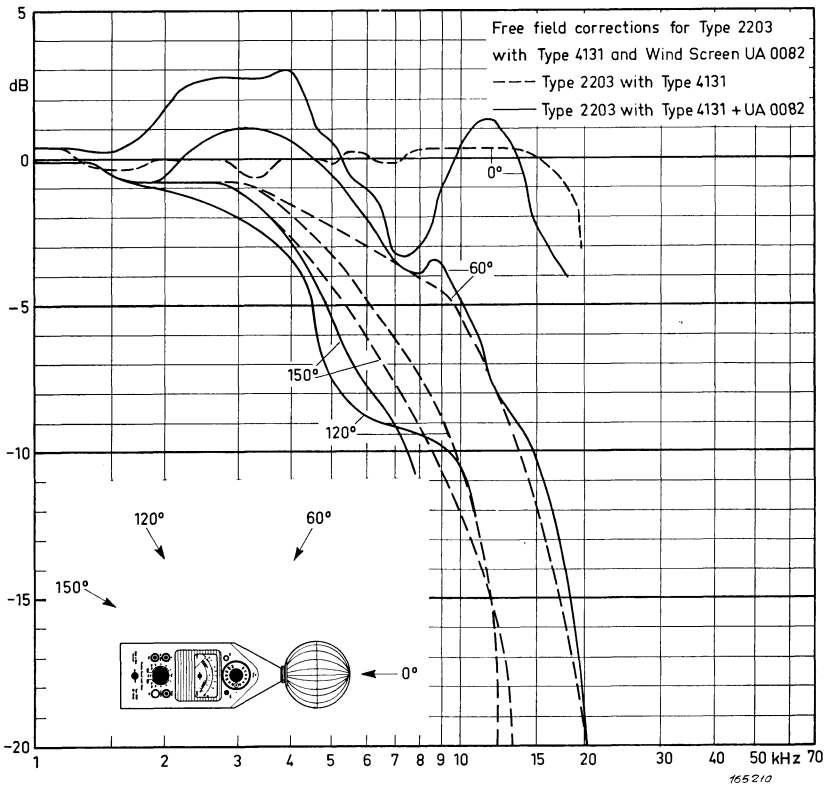

Fig. 8.8. Correction curves for 0°, 60°, 120° and 150° angles of incidence.

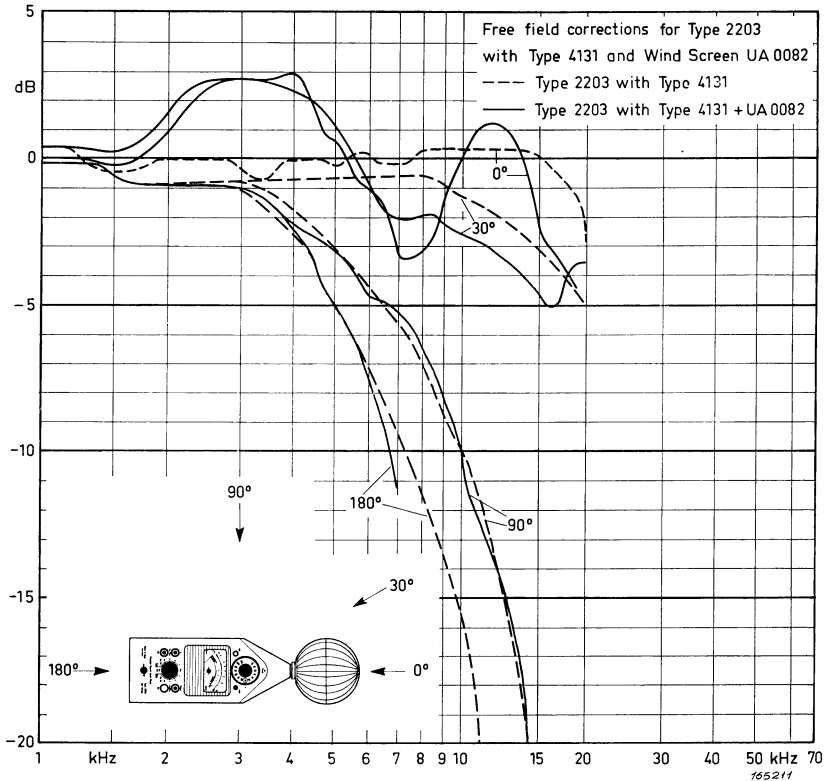

Fig. 8.9. Correction curves for 0°, 30°, 90° and 180° angles of incidence.

Extension Connector UA 0039.

In cases where it is desired to have the microphone separated from the instrument the Extension Connector UA 0039 may be employed. It is a flexible rod of 46 cm (18") length and can be screwed onto the instrument in place of the microphone. The Connector is delivered with an adaptor so that both 1/2" and 1" microphones may be used. The Extension Connector gives an attenuation of 0.1 dB when used with the 1" microphones and 0.2 dB when used with the 1/2" microphones. The Extension Connector is suitable for measurements in ducts or chambers of such dimensions that the Sound Level



Fig. 8.10. Extension Connector UA 0039.

Meter cannot be placed inside, or where the instrument would cause disturbance in the sound field under investigation. Another example is when the Sound Level Meter would be subjected to temperatures higher than 60° C for a long period of time.

Extension Cable AO 0033.

The Extension Cable is a 3 metre (10 ft.) long cable which can be used in place of the Extension Connector when the microphone has to be placed a greater distance away from the Sound Level Meter, or when greater flexibility is required. The attenuation introduced by the cable is 0.1 dB approximately with 1" microphones and 0.3 dB approximately with 1/2" microphone, due to the Extension Cable AO 0033 + Adaptor UA 0030. For precision sound level measurements it is advisable to calibrate the whole system using the Pistonphone Type 4220.

The minimum dynamic levels for measurement are somewhat greater than for the standard instrument. They are:

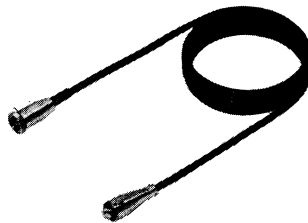

Fig. 8.11. Extension Cable AO 0033.

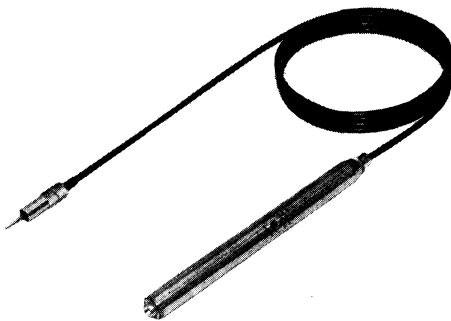

Fig. 8.12. Cathode Follower Type 2630.

		1" micr.
Overall S.P.L.	dB	40
Weighted	dB	26
Octave		20 ¹⁾
(1/3 Octave)		18 ²⁾

1) $f > 200$ Hz

2) $f > 100$ Hz

Cable microphonics are more than 20 dB down on the microphone signal. The input impedance for the 2203 + AO 0033 is 2 Gohm approximately in parallel with 3.2 pF.

Battery Driven Cathode Follower Type 2630.

The battery driven cathode follower is a convenient aid when the transducer has to be situated at some distance from the indicating meter. It has a low output impedance (300 Ω) so that relatively long cables may be used. Input impedance: 270 M Ω in parallel with 3 pF.

Carrying Case Type KE 0011.

This is a convenient carrying case for Type 2203 holding not only the instrument with Filter Set 1613 but also all the accessories necessary to make the Sound Level Meter a really versatile and accurate sound and vibration measuring instrument.

With these accessories the Precision Sound Level Meter is capable of measuring sound pressure levels with an absolute accuracy better than 0.3 dB, and to frequency analyse sound and vibration with octave filters.

The carrying case has compartments for the following items:



Precision Sound Level Meter

Type 2203

Octave Filter Type 1613

Pistonphone Type 4220

Barometer UZ 0001

Connector UA 0039

Condenser Microphone
Type 4131

Extra Microphone (Type 4133)

Accelerometer Type 4312-15

Integrator ZR 0020

Extension Cable AO 0033

Artificial Ear Type 4152 or

Windscreen UA 0082

Random Incidence Corrector
UA 0055

1" Nose Cone UA 0051

1/2" Nose Cone UA 0052

Screwdrivers

Spare Batteries

Tripod Adaptor UA 0028

As the individual requirements to the various accessories may differ considerably, the case is not necessarily ordered as a set, but can be ordered with the accessories necessary for any particular investigation.

9. Applications

The Sound Level Meter is an extremely versatile instrument which finds many applications in the measurement of sound, vibration or electrical signals in the audio-frequency range. In conjunction with other B & K instruments it makes up complete measuring-analyzing-recording systems for thorough investigation into the above fields. The individual research engineer will know himself what he wants to use the Sound Level Meter for, but a short list of applications are included here in order to give an idea of the versatility of the instrument.

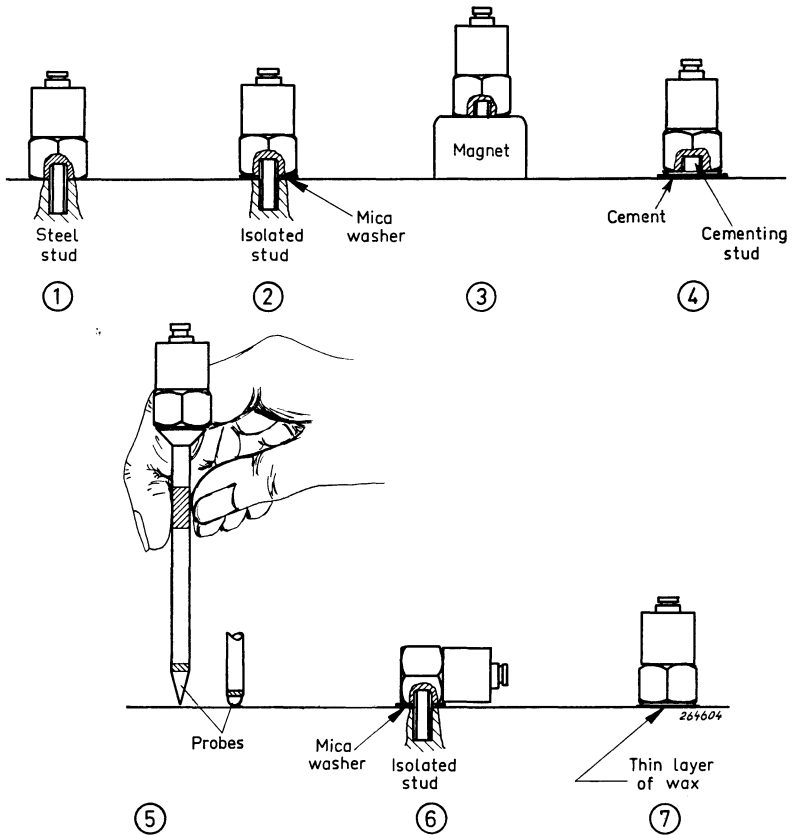

Fig. 9.1. Different ways of mounting the Accelerometer.

Noise Measurements.

The measurement of noise is the prime function of the instrument and the main reason for making it portable. It is easily transported to the place where measurements are to be taken, and its simplicity of operation makes it convenient for the layman to use as well as the trained engineer.

Most countries now have regulations for how to measure noise and what sound levels are allowable in each particular case, and the user is referred to these regulations for more information before starting to make measurements, if the results are for official use. See also the chapter on "Loudness Evaluation and Noise Rating" on page 7.

Measurement of Vibration.

Using a B & K accelerometer and the Integrator ZR 0020 instead of the microphone converts the Sound Level Meter into a portable vibration meter. The accelerometer can be fixed to the specimen, and because of its small size and weight it will have a negligible effect on the natural vibrations unless the specimen is very small. As an example of application let us take the measurement of vibration on a flat plate in order to determine the way it breaks up into a nodal pattern. In this case it is convenient to use the accelerometer with a probe, see Fig. 9.1, and hold the probe against the plate by hand. For hand-held operation the response of the accelerometer is linear up to about 1000 Hz. If higher frequencies are expected, the accelerometer should be fixed onto the vibrating body with a screw or stuck on with wax. See Fig. 9.1.

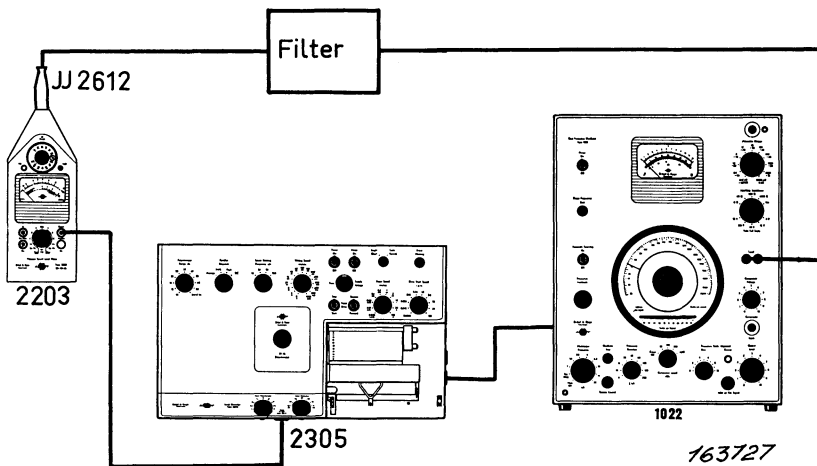

Fig. 9.2. Set-up for finding the frequency response of a 4-pole network.

Frequency Response of 4-pole Networks.

The frequency characteristics of audio-frequency filter networks are easily determined using the Sound Level Meter in conjunction with a B & K Beat Frequency Oscillator e.g. Type 1022 and the Level Recorder Type 2305. See the set-up in Fig. 9.2. An example of the output from the Level Recorder is shown in Fig. 9.3.

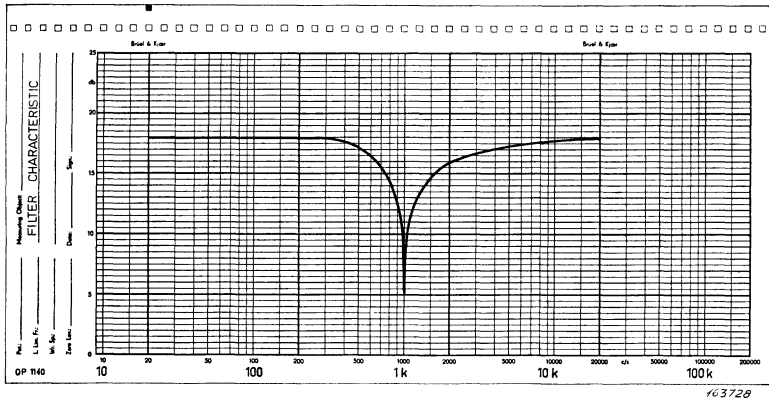

Fig. 9.3. Output from the Level Recorder.

Tape Recording of Sound and Vibration Data.

Sound and vibration data often yield maximum information when stored on a tape recording. By forming the tape into a loop, transient phenomena, such as sound from a passing vehicle, reverberation after a gun-shot etc., can be played back continuously and analysed with B & K frequency or spectrum analyzers.

The 2203 is ideally suited for feeding a tape recorder, for example a battery operated model. The Sound Level Meter OUTPUT socket should be connected to a tape recorder having an input impedance of at least 10 kohm. With a 10 kohm load the maximum peak output voltage is 10 V, and full scale deflection on the meter corresponds to about 3 V RMS regardless of knob setting. 1 V RMS output is indicated by roughly 1/3 scale deflection, i.e. about 0 dB on the main scale, and since many instrumentation tape recorders require a nominal recording level of 1 V RMS, the Sound Level Meter is an excellent recording-level monitor. More than this, it is an ideal "calibrated source" because whatever the input signal the output from the Sound Level Meter is within a suitable, known range.

Even in the case of a recorder requiring 3 V RMS input there is little chance of peak limiting, because 10 V is acceptable and this allows a peak RMS ratio of more than 3.

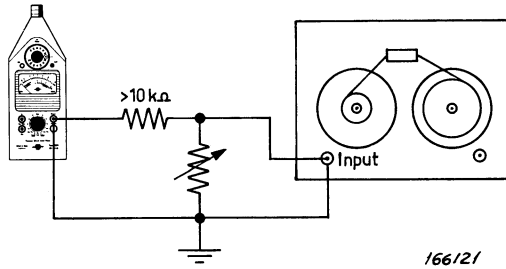

166121

Fig. 9.4. The sound Level Meter used with a tape recorder.

In the case of a tape recorder requiring a recording level less than 3 V, an attenuator such as the one shown in Fig. 9.4 should be inserted between the Sound Level Meter and the recorder.

Before and after the recording, two reliable spot calibration signals can be put on the tape. One is from a Pistonphone Type 4220 and represents a sound pressure level of 124 dB at 250 Hz. Since the dynamic range of a tape recorder is usually comparatively small it is best to shift the Pistonphone signal with the aid of the Sound Level Meter attenuators, to roughly the same range as the signals of interest, noting down the shift in dB. The other calibration signal comes from the Sound Level Meter itself and is a check on sensitivity and frequency characteristic of the whole set-up. This signal is the 1 kHz square wave which appears when the Sound Level Meter controls are set to "Ref". The equivalent sound pressure level is 6 dB + K-factor of the microphone cartridge + the reading on knobs 2 and 3 used when recording (+ possible extra correction due to extension connector used for the microphone).

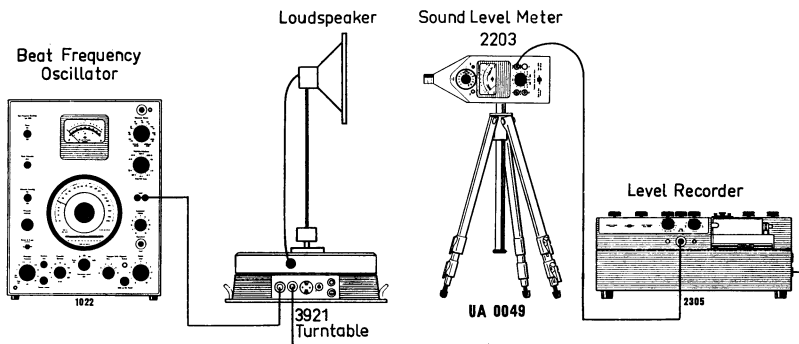

163717

Fig. 9.5. Set-up for finding frequency response and directivity pattern of a loudspeaker.

Frequency Response and Directivity Pattern of Loudspeakers.

The Sound Level Meter is very well suited for obtaining the frequency response and the directivity pattern of sound sources. An example is given in Fig. 9.5, where the loudspeaker to be tested is placed on a Turntable Type 3921 and fed from a B & K Beat Frequency Oscillator Type 1022, covering the frequency range 20 to 20000 Hz. The Level Recorder can take polar recording paper as well as ordinary lengths, and the motion of the Turn-

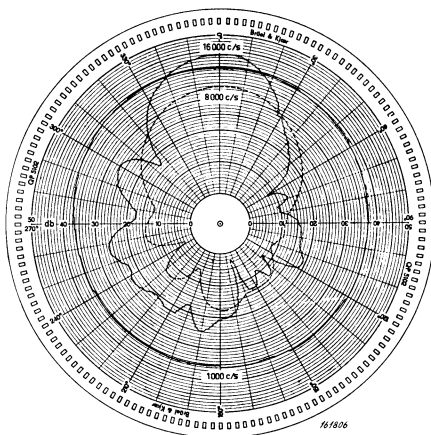

Fig. 9.6. Directivity pattern of the loudspeaker obtained from the set-up of Fig. 9.5.

table is synchronized with the paper drive of the Recorder to give the directivity pattern directly. The results obtained from such a test are given in Fig. 9.6.

Statistical Distribution of Sound Levels.

Used in connection with the B & K Statistical Distribution Analyzer Type 4420 the Sound Level Meter may be used for collecting statistical data on noise and vibration. The Statistical Distribution Analyzer consists mainly of a pulse generator and thirteen digital counters. The pulses are distributed to twelve of the counters from the writing arm of the B & K Level Recorder Type 2305. The writing width of the Level Recorder is divided into ten bands*) and the number of counts indicate how much time the writing stylus has spent in each band, giving the statistical distribution of the sound level with respect to time. The Distribution Analyzer can also be set to cumulative

*) The writing width of the Level Recorder can cover signal variations of 10, 25, 50 or 75 dB depending on which potentiometer is used.

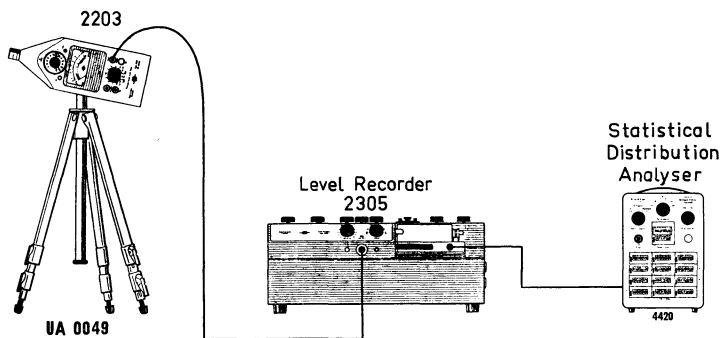

163718

Fig. 9.7. Set-up for finding the statistical distribution of sound level during a day.

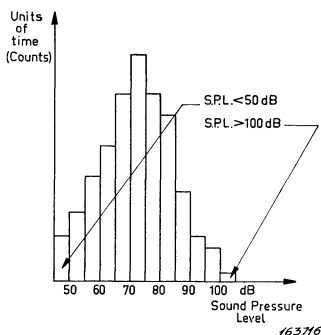

Fig. 9.8. Statistical distribution of sound pressure level on a street corner during a day.

distribution, i.e. it gives the total time that the signal has exceeded a certain level.

One counter counts the total number of pulses and thus relative distribution curves can be made up from the data given by the counters.

A sketch of the set-up for finding the statistical distribution of the sound pressure level on a street corner during a day is given in Fig. 9.7, and the data obtained are given in Fig. 9.8. See B & K Technical Review No. 1, 1964.

Sound and Vibration Spectrograms.

When the Band-Pass Filter Set Type 1612 is connected to the EXT. FILTER sockets of the Sound Level Meter and the Level Recorder Type 2305 to the OUTPUT socket, complete octave and 1/3 octave spectrograms of sound and vibration signals can be recorded automatically. The pulses required to drive

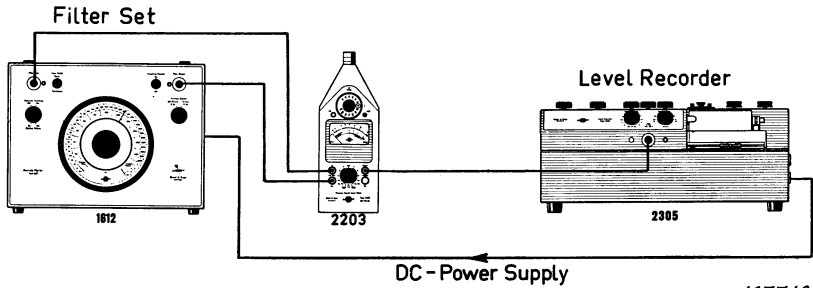

163719

Fig. 9.9. Set-up for the recording of noise spectrograms.

the Filter Set switching mechanism are supplied by the Level Recorder remote control socket, pins 1 and 2. These should be connected to pins 1 and 2 of the Filter Set remote control socket at the back of the instrument.

The external DC supply required by the Filter Set when used with the Sound Level Meter can also be supplied by the Level Recorder. Pin 6 of the Level Recorder remote control socket should then be connected to pin 5 of the Filter Set remote control socket.

Fig. 9.9 is a sketch of a set-up for obtaining the octave and 1/3 octave spectrograms of the noise produced by a lathe, and Fig. 9.10 gives an example of the data obtained from such a test.

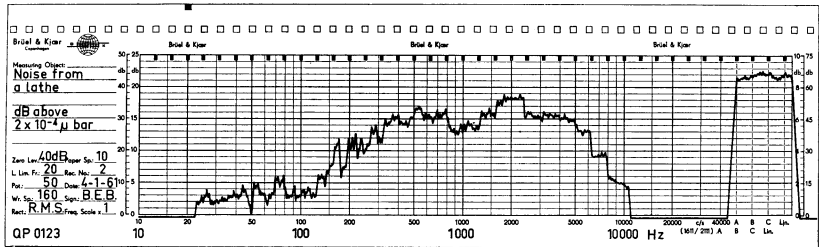

161824

Fig. 9.10. Spectrogram of the noise produced by a lathe.

10. Appendix

The following table is given in order to facilitate the conversion from dB to a (voltage) ratio. It is used as follows:

Subtract a whole number of $n \times 20$ from the dB value to be converted which gives a positive remainder between 0 and 20. Look up the ratio in the table corresponding to the remainder. The value sought is then $10^n \times$ value from the table.

Example: Convert 65.3 dB re. 1 g into units of g.

$$65.3 = (3) \times 20 + 5.3.$$

5.3 gives from table 1.841. The g-value is then $10^3 \times 1.841 = 1841$ g.

With negative values the procedure is the same, e.g.:

Convert -31.8 dB re. 1 g into units of g.

$$-31.8 = (-2) \times 20 + 8.2.$$

8.2 gives from table 2.570. The g-value is then $10^{-2} \times 2.570 = 0.02570$ g.

Table for Converting Decibels into (Voltage) Ratio.

dB	.0	.1	.2	.3	.4	.5	.6	.7	.8	.9
0	1.000	1.012	1.023	1.035	1.047	1.059	1.072	1.084	1.096	1.109
1	1.122	1.135	1.148	1.161	1.175	1.189	1.202	1.216	1.230	1.245
2	1.259	1.274	1.288	1.303	1.318	1.334	1.349	1.365	1.380	1.396
3	1.413	1.429	1.445	1.462	1.479	1.496	1.514	1.531	1.549	1.567
4	1.585	1.603	1.622	1.641	1.660	1.679	1.698	1.718	1.738	1.758
5	1.778	1.799	1.820	1.841	1.862	1.884	1.905	1.928	1.950	1.972
6	1.995	2.018	2.042	2.065	2.089	2.113	2.138	2.163	2.188	2.213
7	2.239	2.265	2.291	2.317	2.344	2.371	2.399	2.427	2.455	2.483
8	2.512	2.541	2.570	2.600	2.630	2.661	2.692	2.723	2.754	2.786
9	2.818	2.851	2.884	2.917	2.951	2.985	3.020	3.055	3.090	3.126
10	3.162	3.199	3.236	3.273	3.311	3.350	3.388	3.428	3.467	3.508
11	3.548	3.589	3.631	3.673	3.715	3.758	3.802	3.846	3.890	3.936
12	3.981	4.027	4.074	4.121	4.169	4.217	4.266	4.315	4.365	4.416
13	4.467	4.519	4.571	4.624	4.677	4.732	4.786	4.842	4.898	4.955
14	5.012	5.070	5.129	5.188	5.248	5.309	5.370	5.433	5.495	5.559
15	5.623	5.689	5.754	5.821	5.888	5.957	6.026	6.095	6.166	6.237
16	6.310	6.383	6.457	6.531	6.607	6.683	6.761	6.839	6.918	6.998
17	7.079	7.161	7.244	7.328	7.413	7.499	7.586	7.674	7.762	7.852
18	7.943	8.035	8.128	8.222	8.318	8.414	8.511	8.610	8.710	8.810
19	8.913	9.016	9.120	9.226	9.333	9.441	9.550	9.661	9.772	9.886

Specifications

Measuring Range:

1" Microphone

Linear	38 —134 dB
C weighting	28 —134 dB
B weighting	21 —134 dB
A weighting	19 —134 dB
Octave	14*—134 dB
1/3 octave	10*—134 dB

1/2" Microphone

Linear	57 —148 dB
C weighting	48 —148 dB
B weighting	43 —148 dB
A weighting	39 —148 dB
Octave	36*—148 dB
1/3 octave	31*—148 dB

*) Valid for frequencies above 500 Hz. Close to the lower limiting frequency these values may be up to 12 dB higher.

These are RMS values. Maximum allowable peak values are 10 dB higher. Signal to noise ratio for lowest level is better than 5 dB. Using Extension Cable AO 0033 the minimum levels are approximately 8 dB higher.

Frequency Response:

Microphones.

B & K Condenser Microphone Type 4131 (1" microphone): Linear from 20 Hz to 15 kHz to within ± 1 dB. Linear from 20 Hz to 18 kHz to within ± 2 dB for 0° incidence in a free field. Sensitivity approximately 5 mV/ μ bar. Temperature coefficient 0.01 dB per $^\circ$ C.

B & K Condenser Microphone Type 4133 (1/2" microphone): Linear from 20 Hz to 30 kHz to within ± 1 dB. Linear from 20 Hz to 40 kHz to within ± 2 dB for 0° incidence in a free field. Sensitivity approximately 1.5 mV/ μ bar. Temperature coefficient 0.01 dB per $^\circ$ C.

Individual calibration charts are supplied with each microphone.

The Amplifiers.

For the temperature range 10 to 60° C (50 to 140° F):

Linear from 40 Hz to 20 kHz to within ± 0.5 dB.

Linear from 20 Hz to 25 kHz to within ± 1 dB.

Linear from 10 Hz to 25 kHz to within ± 2 dB.

For the temperature range — 10 to 60° C (14 to 140° F):

Linear from 200 Hz to 12.5 kHz to within ± 0.5 dB.

Linear from 20 Hz to 20 kHz to within + 1 and — 5 dB.

Amplification 110 dB. Weighting networks A, B, and C are provided.

Meter:

The meter is graduated from — 10 to + 10 dB. Scale divisions of 1 dB from — 10 to 0 dB. Scale divisions of 0.5 dB from 0 to + 10 dB. Scale accuracy 0.5 dB for deflections lower than 0 dB and (0.2 dB + 3 % of the number of dB down from full scale deflection) for values higher than 0 dB. Attenuator steps of 10 dB. Accuracy of attenuator switching 0.2 dB. The meter rectifier is of the square-law type. Two damping characteristics are provided, "Slow" and "Fast", both in accordance with IEC Recommendation; Publication 179.

Facilities for battery checking are included.

Input Impedance:

Approximately 2 Gohm ($G = 10^9$) in parallel with 2.6 pF. With Extension Cable AO 0033, 2 Gohm in parallel with 3.2 pF.

Output:

Output impedance 350 ohm. Maximum capacitive load 1000 pF. The meter indication is affected less than 0.5 dB for a load of 10 kohm. Maximum output voltage 13 V peak on open circuit, 10 V peak loaded with 10 kohm. Full deflection on the meter corresponds to an output voltage of about 3 V RMS.

External Filters:

The output impedance of the first amplifier at the EXT. FILTER IN socket is 25 ohm. The input impedance of the second amplifier at the EXT. FILTER OUT socket is 146 kohm.

Inherent Noise:

Linear: maximum 30 μ V referred to input.

Curve A: maximum 4 μ V referred to input.

Polarization Voltage: Stabilized supply of 200 V.

Calibration: The complete instrument is calibrated acoustically by means of a pistonphone at 250 Hz. Tolerance 0.2 dB. The calibration is valid for measurements in free field with 0° incidence. An electrical calibration signal is built-in to check the amplifiers and meter circuit. An insulating ring for series connection with the microphone can be provided for Insert Voltage Method of calibration.

Directional Characteristics:

At lower frequencies the instrument is completely omnidirectional with no disturbing obstacles nearby. Towards higher frequencies the sensitivity varies with angle of incidence. At 90° the variation is within ± 1 dB up to 3 kHz $\begin{matrix} +1 \\ -2 \end{matrix}$ dB at 4 kHz $\begin{matrix} +1 \\ -7 \end{matrix}$ dB at 8 kHz and $\begin{matrix} +1 \\ -12.5 \end{matrix}$ dB at 12.5 kHz. By using a Random Incidence Corrector UA 0055 the figures are $\begin{matrix} +0 \\ -3 \end{matrix}$ dB at 8 kHz and $\begin{matrix} +0 \\ -6 \end{matrix}$ dB at 12 kHz. Used with the 1/2" Microphone Type 4133 the variation up to 90° is within ± 1 dB at 4 kHz $\begin{matrix} +1 \\ -3 \end{matrix}$ dB at 8 kHz and $\begin{matrix} +1 \\ -6 \end{matrix}$ dB at 12.5 kHz.

Effect of Humidity: The instrument is intended to operate within the humidity range of 0 to 90 %, and it is affected to less than 0.5 dB within this range. When subjected to extreme humidity for a considerable length of time it may be necessary to re-calibrate the instrument by means of the Pistonphone Type 4220 or other acoustical calibration method.

Effect of Vibration: The effect of vibration is shown in Fig. 5.7 for an excitation of 1 g.

Effect of Sound Field upon the Amplifier:

Exposed to a sound field of approximately 120 dB and with the microphone replaced by an equivalent impedance, the deflection on the meter is more than 60 dB less than what it would be with the microphone in place.

Effect of

Magnetic Fields:

When placed in a magnetic field of 50 oersted at a frequency of 50 Hz the meter deflection corresponds to a reading of 70 dB S.P.L.

The sensitivity to electrostatic fields is extremely low as long as the microphone protection grid is in place.

Effect of Variation in Static Pressure:

The effect of a 10 % variation in the ambient static pressure is less than 0.2 dB.

Batteries:

3 × 1.5 Volt flash-light cells. Battery life: 25 hours of intermittent operation or 10 hours of continuous operation.

3 × 1.5 Volt mercury cells. Battery life: 85 hours of continuous operation. The mercury cells also have the advantage of an almost unlimited storage life.

Dimensions:

Height: 31 cm (12.5 inches)

Width: 12 cm (5 inches)

Depth: 9 cm (4 inches)

Weight:

2.7 kg (6 lbs.).

